

Safety, health and welfare on construction sites A training manual

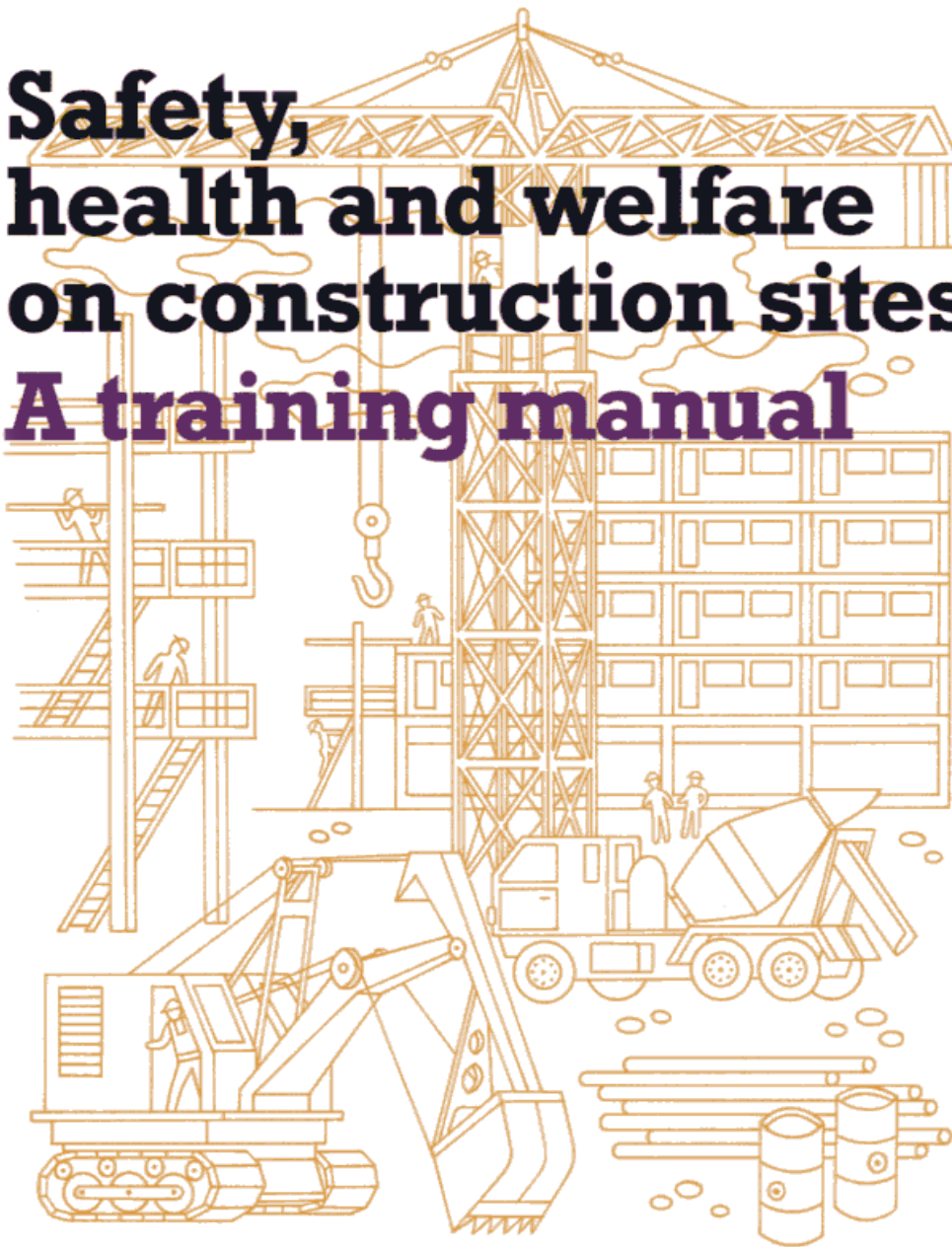

International Labour Office Geneva

Grateful thanks are due to the Joint Industrial Safety Council of Sweden for the use of figures 33, 38, 43, 44, 45, 47 and 54, which are taken from the training manual *Safety, health and working conditions* (Stockholm, 1987).

The International Programme for the Improvement of Working Conditions and Environment (PIACT) was launched by the International Labour Organization in 1976 at the request of the International Labour Conference and after extensive consultations with member States.

PIACT is designed to promote or support action by member States to set and attain definite objectives aiming at “making work more human”. The Programme is thus concerned with improving the quality of working life in all its aspects: for example, the prevention of occupational accidents and diseases, a wider application of the principles of ergonomics, the arrangement of working time, the improvement of the content and organization of work and of conditions of work in general, and a greater concern for the human element in the transfer of technology. To achieve these aims, PIACT makes use of and coordinates the traditional means of ILO action, including:

- the preparation and revision of international labour standards;
- operational activities, including the dispatch of multidisciplinary teams to assist member States on request;
- tripartite meetings between representatives of governments, employers and workers, including industrial committees to study the problems facing major industries, regional meetings and meetings of experts;
- action-oriented studies and research; and
- clearing-house activities, especially through the International Occupational Safety and Health Information Centre (CIS) and the Clearing-house for the Dissemination of Information on Conditions of Work.

This publication is the outcome of a PIACT project.

**Safety, health and welfare
on construction sites**

A training manual

Safety, health and welfare on construction sites

A training manual

International Labour Office Geneva

Copyright © International Labour Organization 1995
First published 1995
Second impression 1999

Publications of the International Labour Office enjoy copyright under Protocol 2 of the Universal Copyright Convention. Nevertheless, short excerpts from them may be reproduced without authorization, on condition that the source is indicated. For rights of reproduction or translation, application should be made to the Publications Bureau (Rights and Permissions), International Labour Office, CH-1211 Geneva 22, Switzerland. The International Labour Office welcomes such applications. Libraries, institutions and other users registered in the United Kingdom with the Copyright Licensing Agency, 90 Tottenham Court Road, London W1P 0LP (Fax: +44 171 631 5500), in the United States with the Copyright Clearance Center, 222 Rosewood Drive, Danvers, MA 01923 (Fax: +1 508 750 4470), or in other countries with associated Reproduction Rights Organizations, may make photocopies in accordance with the licences issued to them for this purpose.

ILO

Safety, health and welfare on construction sites: A training manual
Geneva, International Labour Office, 1995

/Trainers manual/, /Occupational safety/, /Occupational health/, /Construction industry/. 13.04.2

ISBN 92-2-109182-1

ILO Cataloguing in Publication Data

The designations employed in ILO publications, which are in conformity with United Nations practice, and the presentation of material therein do not imply the expression of any opinion whatsoever on the part of the International Labour Office concerning the legal status of any country, area or territory or of its authorities, or concerning the delimitation of its frontiers.

The responsibility for opinions expressed in signed articles, studies and other contributions rests solely with their authors, and publication does not constitute an endorsement by the International Labour Office of the opinions expressed in them.

Reference to names of firms and commercial products and processes does not imply their endorsement by the International Labour Office, and any failure to mention a particular firm, commercial product or process is not a sign of disapproval.

ILO publications can be obtained through major booksellers or ILO local offices in many countries, or direct from ILO Publications, International Labour Office, CH-1211 Geneva 22, Switzerland. Catalogues or lists of new publications are available free of charge from the above address.

Preface

With a view to reducing the incidence of injuries and illnesses among workers in the construction industry, the International Labour Conference adopted in 1988 the Safety and Health in Construction Convention (No. 167), and Recommendation (No. 175).

The ILO has worked diligently in numerous countries to carry out its programme of promoting the implementation of ILO standards in safety and health in the construction industry. A major contribution to this important effort was made possible by an ILO/UNDP Project on the Promotion of Safety, Health and Welfare in the Construction Industry (RAS/86/072). This project, which went into force in 1988, provided assistance to 12 participating Asian countries to improve safety, health and welfare programmes for preventing occupational accidents and diseases in the construction industry. Through this project and other programmes, the ILO encourages participating countries to strengthen national infrastructures which can help sustain their capabilities after ILO projects or programmes have terminated. These ongoing efforts are particularly important for promoting national action towards reinforcing the capacity for training in the safety and health of construction workers and management, and for improving the collection and analysis of relevant statistical data aimed at prevention.

The need for a training manual for those engaged in or concerned with the construction industry was recognized early in the

implementation of the ILO/UNDP project by the policy-makers from the participating countries. This manual – a revised and expanded version of a 1990 edition – has been elaborated through the project and developed primarily for construction site workers, their representatives and the workers' immediate supervisors. It is intended to be complementary to the ILO code of practice, Safety and health in construction, published by the ILO in 1992, which contains practical recommendations for the use of all those, both in the public and private sectors, who have responsibility for safety and health in construction. The contents will, however, also be of direct concern to employers and management on whom many of the duties and responsibilities fall for creating safe and healthy working conditions. The manual is published with the expressed hope that it will be adapted to local working practices and translated into the language of the end-user.

The ILO appreciates the assistance given by Mr. Victor Jordan, formerly H.M. Deputy Chief Inspector of Factories of the Health and Safety Executive, United Kingdom, in the preparation of the text of the manual. Thanks are also due to Noha Karanuh and Igor Losavio, who drew the illustrations.

Dr. Chandra Pinnagoda,

*Chief,
Occupational Safety and Health Branch
Working Conditions and Environment Department*

Contents

Preface.....	v	5.6.2	Suspension ropes.....	26
1. Introduction.....	1	5.6.3	The platform.....	27
The purpose of the manual.....	1	5.6.4	Erection and training.....	27
2. Safety organization and management	3	6. Ladders	29	
2.1 Safety policies	3	6.1	Limitations	29
2.2 Safety organization.....	3	6.2	Secure your ladder	29
2.2.1 Safety officer/manager	5	6.3	Safe use of ladders	30
2.2.2 Supervisors	6	6.4	Care of ladders	31
2.2.3 Workers	6	6.5	Stepladders.....	32
2.3 Safety committees	6	7. Hazardous processes.....	33	
2.4 Safety representatives	7	7.1	Roof work	33
2.5 Outside agencies.....	7	7.1.1	Flat roofs	33
2.5.1 Government intervention.....	7	7.1.2	Sloping roofs.....	34
2.5.2 International agreements	8	7.1.3	Fragile roofs.....	34
3. Site planning and layout.....	9	7.1.4	Crawling boards and roof ladders.....	36
3.1 Site layout.....	9	7.2	Steel erection.....	37
3.2 Site tidiness.....	10	7.2.1	Design planning	37
4. Excavations.....	13	7.2.2	Supervision	37
4.1 General measures.....	13	7.2.3	Work preparation	37
4.1.1 Hazards.....	13	7.2.4	Means of access to working areas	38
4.1.2 Causes of accidents.....	13	7.3	Work over water.....	40
4.1.3 Safety precautions to prevent the collapse of excavations, and falls	13	7.4	Demolition	41
4.1.4 Inspection	14	7.4.1	Planning and training	41
4.1.5 Adjoining buildings	14	7.4.2	The demolition process	42
4.1.6 Edges	14	7.4.3	Tanks and vessels.....	43
4.1.7 Vehicles	15	7.4.4	Health hazards.....	43
4.1.8 Access.....	15	7.5	Confined spaces	43
4.1.9 Lighting	15	7.5.1	Hazards	43
4.2 Buried or underground services.....	16	7.5.2	Safety precautions.....	44
4.2.1 Electrical cables.....	16	7.5.3	Safety and rescue equipment...	45
4.2.2 Other services	16	7.6	Piling.....	46
5. Scaffolding.....	19	7.6.1	General precautions.....	46
5.1 Hazards.....	19	7.6.2	Bored piles	46
5.2 Independent tied scaffolds	19	8. Vehicles.....	47	
5.2.1 Ties	20	8.1	Causes of accidents	47
5.2.2 Working platforms and gangways	20	8.2	Safety precautions	47
5.2.3 Guard-rails and toe boards.....	21	8.3	Overturning	48
5.3 Single pole or putlog scaffolds	21	8.4	Loading	49
5.4 Tower scaffolds	23	9. Movement of materials	51	
5.4.1 Causes of accidents.....	23	9.1	Cranes	51
5.4.2 Height limitations	24	9.1.1	Erection	51
5.4.3 Structure	24	9.1.2	Signalling	51
5.4.4 The working platform.....	24	9.1.3	Overloading.....	51
5.4.5 Movement.....	25	9.1.4	Safe load indicators.....	51
5.5 Trestle scaffolds.....	25	9.1.5	Inspection and maintenance ...	52
5.6 Suspended scaffolds	26	9.1.6	Mobile cranes.....	52
5.6.1 Access to the scaffold.....	26	9.1.7	Tower cranes	53
		9.1.8	Cranes used in demolition.....	54

9.1.9	Lifting appliances used as cranes	54	11.2.3	Lead.....	78
9.1.10	Slings and ropes	54	11.3	AIDS.....	78
9.2	Goods hoists.....	54	11.3.1	Precautions	78
9.2.1	Erection.....	55	11.3.2	First aid.....	79
9.2.2	Enclosure	55	11.4	Noise and vibration.....	79
9.2.3	Safety devices	55	11.4.1	Noise control	79
9.2.4	Operation	55	11.4.2	Hearing protection	80
9.2.5	Loads.....	55	11.4.3	Vibration.....	80
9.2.6	Carriage of persons	55	11.5	Lighting	80
9.2.7	Testing and examination	55	11.6	Exposure to heat and cold.....	81
9.3	Gin or pulley wheels	56	11.6.1	Hot weather	81
9.3.1	Causes of accidents	56	11.6.2	How to keep cool.....	81
9.3.2	Safety measures	57	11.6.3	Cold weather.....	81
9.4	Manual handling	57	11.6.4	How to keep warm	82
9.4.1	Lifting and carrying	58			
9.4.2	Lifting technique.....	58			
10.	Working positions, tools and equipment	61	12.	Personal protective equipment (PPE)	83
10.1	Fitting work to people: Ergonomics.....	61	12.1	Why do you need PPE?	83
10.1.1	Strenuous and heavy physical work	61	12.2	Head protection	83
10.1.2	Static loads	62	12.3	Foot protection.....	83
10.1.3	Working postures	62	12.4	Hand and skin protection	85
10.1.4	Sitting and standing positions ..	63	12.5	Eye protection.....	85
10.1.5	Work in cabins	63	12.6	Respiratory protection	86
10.2	Hand tools	63	12.6.1	Correct choice of respirator	86
10.2.1	Selection, use and maintenance.....	64	12.7	Safety harness.....	88
10.3	Power-driven machinery	64	13.	Welfare facilities	89
10.3.1	Hazards	64	13.1	Why welfare facilities?.....	89
10.3.2	Safety precautions	65	13.2	Sanitary facilities	90
10.3.3	Circular saws.....	66	13.3	Washing facilities	90
10.3.4	Compressed air tools.....	66	13.4	Facilities for supplying food and drink, and eating meals	90
10.3.5	Cartridge-operated tools.....	66	13.4.1	The meal area	91
10.4	Electrical equipment	67	13.4.2	Drinking-water	91
10.4.1	Electric shock.....	67	13.5	Facilities for changing, storing and drying clothes	92
10.4.2	Treatment for electric shock ...	68	13.6	Rest breaks	92
10.4.3	Existing supplies	68	13.6.1	Frequency of rest breaks.....	92
10.4.4	Electrical installations.....	68	13.7	Child-care facilities	92
10.4.5	Portable electrical tools and equipment.....	69	13.7.1	Basic provisions	92
10.5	Welding and cutting	70	13.7.2	Watch the children's movements.....	92
10.5.1	Electric arc welding	70	13.8	First aid.....	93
10.5.2	Gas welding	71	13.8.1	Emergency action	93
10.5.3	Fumes.....	71	13.8.2	Equipment and training	94
10.6	Liquefied petroleum gases	71	13.8.3	Moving an injured person.....	94
10.6.1	Storage	72	13.8.4	Investigation	94
10.6.2	Handling.....	72	13.9	Fire precautions	94
11.	The working environment	73	Annexes	97	
11.1	Chemical substances	73	1.	Safety, health and welfare on construction sites: Check-list.....	97
11.1.1	Chemicals and their risks	73	2.	The Safety and Health in Construction Convention, 1988 (No. 167), and Recommendation, 1988 (No175).....	111
11.1.2	Entry into the body.....	73			
11.1.3	Preventive measures.....	74			
11.1.4	Highly flammable chemicals ..	76			
11.2	Hazardous substances	76			
11.2.1	Cement.....	76			
11.2.2	Asbestos.....	77			

Figures

1. Safety organization and management must cover all aspects of the employer’s or the contractor’s operations4	23. Edge protection for flat roof – a real-life example 34
2. “Tool-box briefing” should be carried out regularly7	24. Sloping roofs: Two methods of providing edge protection 35
Figures 3 and 4. Bad site layout and lack of space prevent safe movement of workers and vehicles and cause accidents.....9	25. Roof ladder for work on a sloping roof or over fragile materials..... 36
5. Edge protection: Guard-rails and toe boards at open edges of floors and working platforms to prevent workers from falling10	26. Roof ladder with ridge iron to place over roof ridge..... 37
6. Clean up spilt oil or grease11	27. Mobile hydraulic platforms provide safe means of access for steel erectors..... 39
7. Hammer down any nails projecting from timber.....11	28. Use of safety belts and harnesses – different ways of providing safe anchorage points for safety lines..... 39
8. Shoring to prevent the collapse of the sides of an excavation consisting of timber or steel frames with close boarding between frames14	29. Safety nets to prevent falls of steel erectors 40
9. Barriers along the sides of an excavation to prevent workers falling into it.....14	30. A scaffold platform from which demolition may be carried out safely..... 42
10. Excavation near a building: Shoring required to prevent collapse of the building.....14	31. When entering a confined space, use a lifeline with a second person present and self-contained breathing apparatus 45
11. Stop block to prevent vehicles being reversed into an excavation while tipping15	32. Goalposts to compel drivers to lower crane and excavator jibs, and avoid contact with overhead power lines..... 48
12. Locating buried electrical cables from a plan and marking their position17	33. Hand signals to crane drivers should be clear and distinct, and should follow a recognized code or system..... 51
13. An independent tied scaffold which does not rely on the building for its strength. It has inner and outer rows of uprights or standards..20	34. Mobile cranes should operate with outriggers extended to prevent overturning..... 52
14. Working platform showing guard-rail and toe board with wire mesh filling between them and the closely boarded platform.....21	35. Cranes: The need for a safety hook fitted with a latch to prevent displacement of loads is explained to workers..... 53
15. A single pole or putlog scaffold, with a single outer row of uprights or standards and which is partly supported by the building.....22	36. Goods hoist with enclosure and gates to prevent workers being struck by the platform . 56
16. Protection of scaffold from falling materials – scaffold fan and debris netting23	37. A gin wheel should always be secured to at least two supports 57
17. Mobile tower scaffold-wheels should be locked when in use; ladder access should be inside the tower.....24	38. Right and wrong ways to lift a load 59
18. A trestle scaffold suitable only for light work such as cleaning or painting.....26	39. Where possible, workers should not work on surfaces above their heads, as this increases the strain on arms, back and neck..... 62
19. Ladder secured at its upper end, extending above the landing place29	40. Reject worn hand tools – use only those in good condition..... 65
20. Ladder secured at its foot to stop movement ...30	41. Circular saw showing top guard and riving knife behind the saw blade. The top guard is adjusted low over the blade 66
21. Safe use of ladders – allow sufficient overlap of extension-ladder sections; carry tools safely; don’t overreach31	42. Use of hearing and eye protection by the operator of a cartridge gun, who is also wearing a helmet 67
22. Edge protection for flat roof – diagram of what is required33	43. Artificial respiration: Continue mouth-to-mouth resuscitation until medical help arrives 68

44.	Electrical installations – pay special attention to the condition of temporary or portable electrical equipment and its cables	69
45.	Arc welding – workplace earthed, welder wearing personal protective equipment, workplace screened	70
46.	Gas cylinders moved around the site in a trolley in which they are secured upright	71
47.	Chemicals enter the body by inhalation, ingestion and absorption	73
48.	Every chemical used on site should have a label and sufficient information to ensure its safe use	75
49.	An example of a chemical safety data sheet, providing essential safety and health information	75
50.	Chemical spillage soaked up with dry sand	76
51.	Compressor noise control – keep covers closed, use muffler on pneumatic hammer and wear hearing protectors	80
52.	“Hard-hat” areas – all or most parts of construction sites should be marked by signs as “hard-hat” areas	84
53.	Eye protection must be suitable, comfortable and available to encourage workers to wear it	86
54.	Three types of half-face mask with filters	87
55.	Self-contained breathing apparatus, with air supplied from either a compressor or air bottles	88
56.	Suitable washing facilities and lavatories help protect the health of workers	89

1. Introduction

The construction industry is one of the world's major industries. Its achievement in rebuilding areas devastated by both natural and man-made disasters, and in providing power, services and communications to meet the rising needs and expectations of people throughout the world, has conferred great benefits on the human race. Despite mechanization, construction remains a major employer of labour – it often employs between 9 and 12 per cent of a country's working population, and sometimes as much as 20 per cent.

There has, however, been a price to pay for this continuous growth and activity. Although it is difficult to obtain accurate statistics in an industry in which many accidents go undetected and unreported, in many countries known fatal accidents, and those involving loss of working time, frequently exceed those in any other manufacturing industry.

Contributing to the high rate of accidents are those characteristics of the industry which distinguish it from the rest of the manufacturing sector. These are:

- the high proportion of small firms and of self-employed workers;
- the variety and comparatively short life of construction sites;
- the high turnover of workers;
- the large numbers of seasonal and migrant workers, many of whom are unfamiliar with construction processes;
- exposure to the weather;
- the many different trades and occupations.

The purpose of the manual

All of us who have looked for and found a job in construction are concerned that our work should be safe and that conditions on the construction site should not cause damage to our life, our health and our professional skills.

Through this manual – Safety, health and welfare on construction sites – we will help you to consider safety, health and welfare conditions on construction sites in your country and to learn about possible solutions to the problems you encounter.

2. Safety organization and management

Unlike the remainder of this manual, which is intended primarily for workers and their supervisors, this chapter is intended to remind management at a more senior level of the foundations they need to lay to achieve a safe and healthy site. It will also, however, inform workers and supervisors of the essentials of a proper safety management system.

The improvement of safety, health and working conditions depends ultimately upon people working together, whether governments, employers or workers. Safety management involves the functions of planning, identifying problem areas, coordinating, controlling and directing the safety activities at the work site, all aimed at the prevention of accidents and ill health (figure 1). Accident prevention is often misunderstood, for most people believe wrongly that the word “accident” is synonymous with “injury”. This assumes that no accident is of importance unless it results in an injury. Construction managers are obviously concerned with injuries to the workers, but their prime concern should be with the dangerous conditions that produced the injury – with the “incident” rather than the “injury”. On a construction site there are many more “incidents” than injuries. A dangerous act can be performed hundreds of times before it results in an injury, and it is to eliminate these potential dangers that managers’ efforts must be directed. They cannot afford to wait for human or material damage before doing anything. So safety management means applying safety measures before accidents happen. Effective safety management has three main objectives:

- to make the environment safe;
- to make the job safe,
- to make workers safety conscious.

2.1 Safety policies

Safe and healthy working conditions do not happen by chance. Employers need to have a written safety policy for their enterprise setting out the safety and health standards which it is their objective to achieve. The policy should name the senior executive who is responsible for seeing that the standards are achieved, and who has authority to allocate responsibilities to management and supervisors at all levels and to see they are carried out.

The safety policy should deal with the following matters:

- arrangements for training at all levels. Particular attention needs to be given to key workers such as scaffolders and crane operators whose mistakes can be especially dangerous to other workers;
- safe methods or systems of work for hazardous operations: the workers carrying out these operations should be involved in their preparation;
- the duties and responsibilities of supervisors and key workers;
- arrangements by which information on safety and health is to be made known;
- arrangements for setting up safety committees;
- the selection and control of subcontractors.

2.2 Safety organization

The organization of safety on the construction site will be determined by the size of the work site, the system of employment and the way in which the project is being organized. Safety and health records should be kept which facilitate the identification and resolution of safety and health problems on the site.



Figure 1. Safety organization and management must cover all aspects of the employer's or the contractor's operations

In construction projects where subcontractors are used, the contract should set out the responsibilities, duties and safety measures that are expected of the subcontractor's workforce. These measures may include the provision and use of specific safety equipment, methods of carrying out specific tasks safely, and the inspection and appropriate use of tools. The person in charge of the site should also assure that materials, equipment and tools brought on to the site meet minimum safety standards.

Training should be conducted at all levels, including managers, supervisors and workers. Subcontractors and their workers may also need to be trained in site safety procedures, because teams of specialist workers may mutually affect each others' safety.

There should also be a system so that site management has information quickly about unsafe practices and defective equipment.

Safety and health duties should be specifically assigned to certain persons. Some examples of duties which should be listed are:

- provision, construction and maintenance of safety facilities such as access roadways, pedestrian routes, barricades and overhead protection;
- construction and installation of safety signs;
- safety provisions peculiar to each trade;
- testing of lifting machinery such as cranes and goods hoists, and lifting gear such as ropes and shackles;
- inspection and rectification of access facilities such as scaffolds and ladders;
- inspection and cleaning of welfare facilities such as toilets, clothing accommodation and canteens;
- transmission of the relevant parts of the safety plan to each work group;
- emergency and evacuation plans.

Point to remember:

- No safety policy or plan is workable without assigning a specific duty:
 - to a specific person;
 - to be completed at a specific point of time.
- The safety policy and plan must be transmitted down the line to the workers – it is their safety that the plan is intended to safeguard.

2.2.1 Safety officer/manager

Every construction company of any size should appoint a properly qualified person (or persons) whose special and main responsibility is the promotion of safety and health. Whoever is appointed should have direct access to an executive director of the company. His or her duties should include:

- the organization of information to be passed from management to workers, including those of subcontractors;
- the organization and conduct of safety training programmes, including induction training for all workers on the site;
- the investigation and review of the circumstances and causes of accidents and occupational diseases so as to advise on preventive measures;
- acting as consultant and technical adviser to the safety committee;
- participation in pre-site planning.

To carry out these functions the safety officer should have experience of the industry and should be properly trained and qualified and, where such exists, should be a member of a recognized professional safety and health body.

2.2.2 Supervisors

Good planning and organization at each work site and the assignment of clear responsibility to supervisors are fundamental to safety in construction. “Supervisor” here means the first level of supervision, which on site is variously termed as “foreman”, “chargehand”, “ganger”, and so on.

Each supervisor requires the direct support of site management and should seek to assure within his or her field of competence that:

- working conditions and equipment are safe;
- workplace safety is regularly inspected;
- workers have been adequately trained for the job they are expected to do;
- workplace safety measures are implemented;
- the best solutions are adopted using available resources and skills;
- necessary personal protective equipment is available and used.

Making the work site safe will require regular inspection and provision of the means for taking remedial measures. The training of workers enables them to recognize the risks involved and how they can overcome them. Workers should be shown the safe way of getting a job done.

2.2.3 Workers

Every worker is under a moral, and often also a legal, duty to take the maximum care for his or her own safety and that of fellow workers. There are various ways of involving workers directly in site conditions, such as:

- “tool-box briefing” (figure 2), a five- to ten-minute session with the supervisor just prior to starting a task gives the workers and the supervisor a chance to talk about safety problems likely to be encountered and potential solutions to those problems. This activity is simple to implement and it may prevent a serious accident;

- “safety check”; a check by workers that the environment is safe before starting an operation may allow them to take remedial action to correct an unsafe situation that could later endanger them or another worker.

2.3 Safety committees

An active safety committee is a great spur to safety. Its primary purpose is to enable management and workers to work together to monitor the site safety plan so as to prevent accidents and improve working conditions on site. Its size and membership will depend on the size and nature of the site and upon differing legal and social conditions in the countries concerned, but it should always be an action-oriented group of people in which both management and workers are represented. The safety committee carrying out a site inspection together raises the level of safety consciousness at the site. The duties carried out by an active safety committee will include:

- regular and frequent meetings to discuss the safety and health programme on site and to make recommendations to management;
- consideration of reports of safety personnel;
- discussion of accident and illness reports in order to make recommendations for prevention;
- evaluating improvements made;
- examination of suggestions made by workers, particularly by safety representatives;
- planning and taking part in educational and training programmes, and information sessions.

Figure 2. “Tool-box briefing” should be carried out regularly

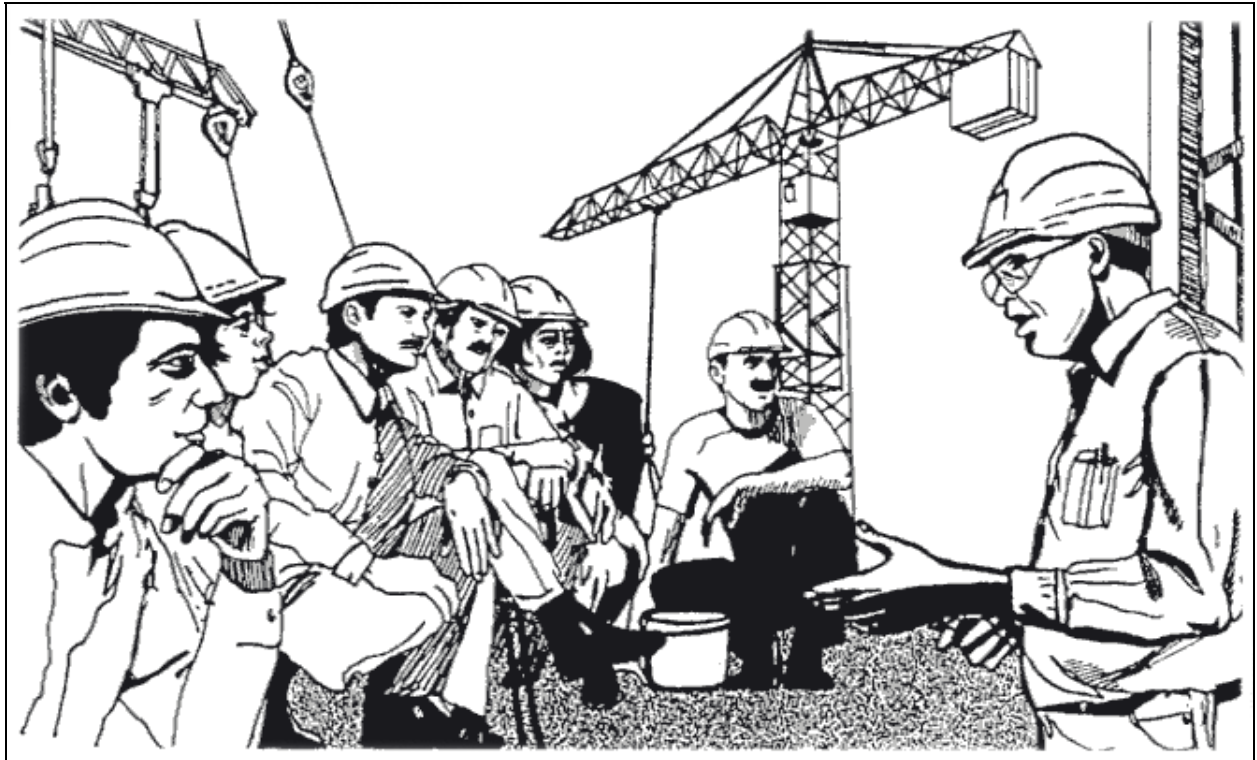

2.4 Safety representatives

These are appointed by workers, sometimes in accordance with national legislation, to represent them in dealing with safety and health matters on site. They should be experienced workers well able to recognize construction site hazards, although they are likely to require training to acquire new skills in inspection and in using information. Their functions are:

- to make representations to the management about matters of concern regarding the safety and health of workers;
- to attend meetings of the safety committee;
- to carry out regular and systematic inspections on site;
- to investigate accidents in conjunction with management to determine their causes and to propose remedies;
- to investigate complaints by workmates;
- to represent workers in discussions with government inspectors at their site visits.

Safety representatives should be given sufficient time off to be trained and to carry out their duties properly. These activities should be without loss of pay, for a safe and healthy site benefits both employers and workers.

2.5 Outside agencies

2.5.1 Government intervention

In many countries there are laws and regulations governing conditions of work in the construction industry. These are usually enforced by factory or labour inspectors who are often also able and willing to provide advice on compliance. However, even in the best-regulated countries the numbers of inspectors are too few to provide day-to-day surveillance on site, even were it their job to do so.

2.5.2 International agreements

National laws and regulations are often based upon international conventions, agreements, declarations and programmes. These have been drawn up by different United Nations organizations including the International Labour Organization (ILO) and the World Health Organization (WHO).

In 1988 the ILO adopted the Safety and Health in Construction Convention (No.167), and its accompanying Recommendation (No.175), which provide a foundation of law on which safe and healthy working conditions can be built. The texts of this essential Convention and Recommendation are reproduced in Annex 2 of this manual.

3. Site planning and layout

3.1 Site layout

A badly planned and untidy site is the underlying cause of many accidents resulting from falls of material and collisions between workers and plant or equipment (figures 3 and 4). Space constraints, particularly in urban work sites, are nearly always the biggest limiting factor and a layout which caters best for the safety and health of workers may appear to be difficult to reconcile with productivity. Proper planning by management is an essential part of preparation and budgeting for the safe and efficient running of a construction operation.

Before work even begins on site, thought needs to be given to:

- the sequence or order in which work will be done and to any especially hazardous operations or processes;
- access for workers on and around the site. Routes should be free from obstruction and from exposure to hazards such as falling materials, materials-handling equipment and vehicles. Suitable warning notices should be posted. Routes to and from welfare facilities need equal consideration. Edge protection will be required at the edge of floor openings and stairs, and wherever there is a drop of 2 m or more (figure 5);

Figures 3 and 4. Bad site layout and lack of space prevent safe movement of workers and vehicles and cause accidents

Bad layout

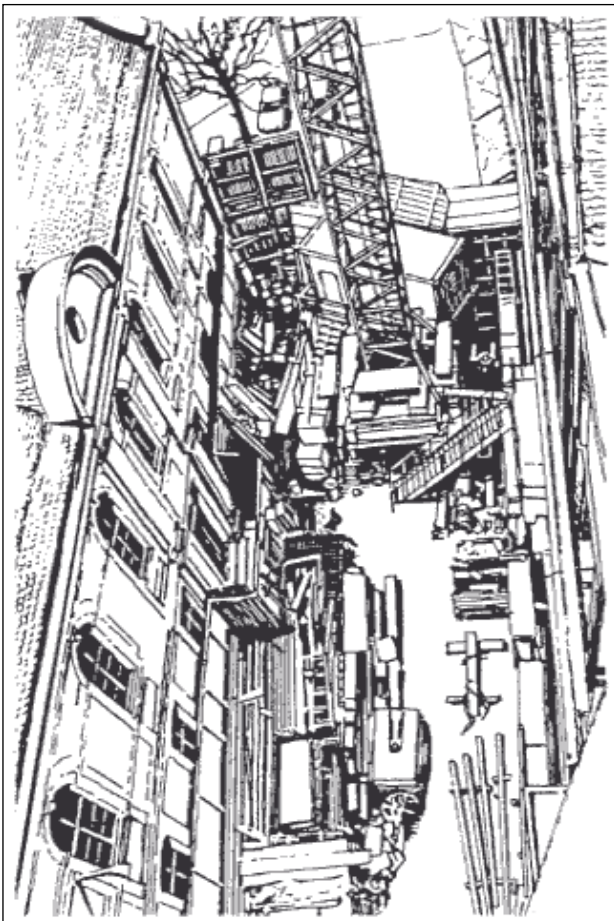

Good layout

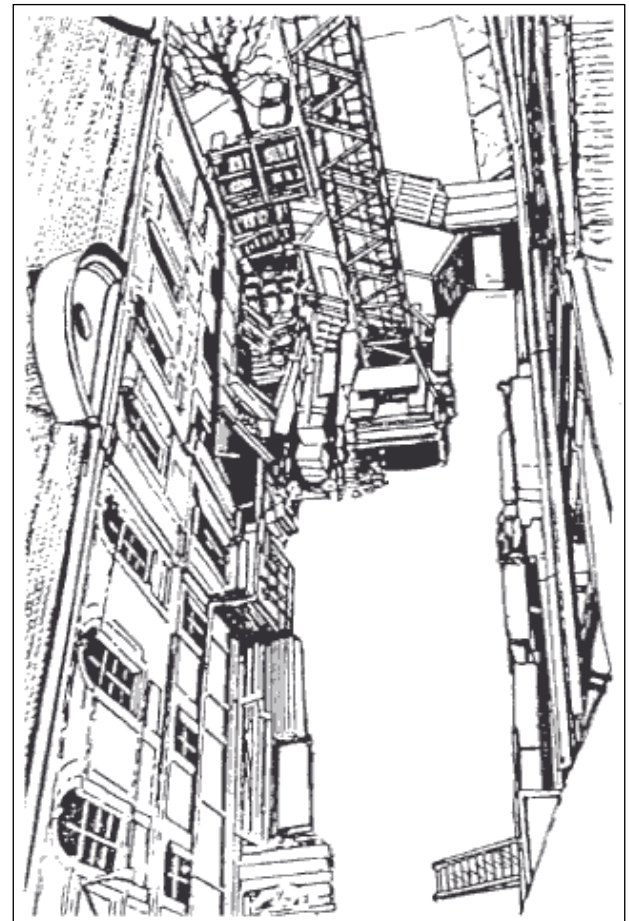
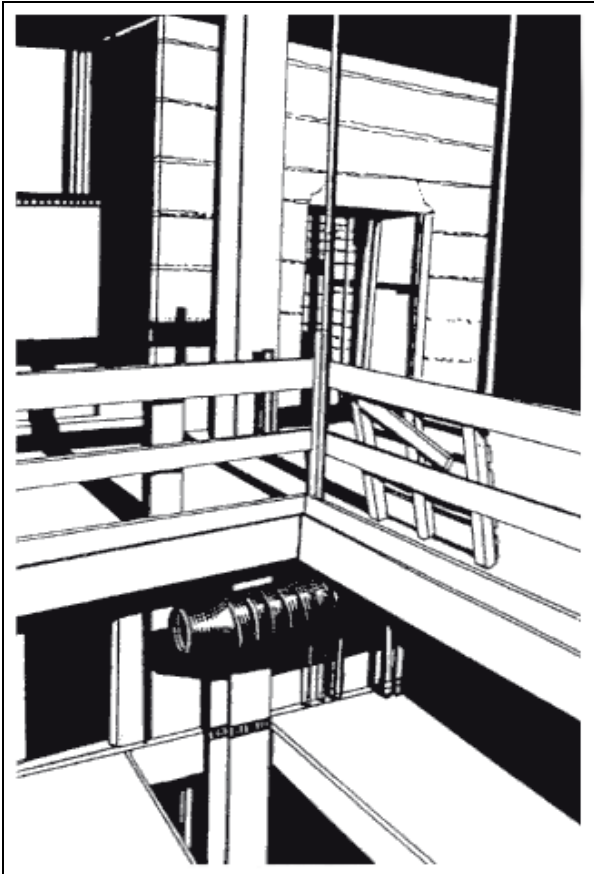

Figure 5. Edge protection: Guard-rails and toe boards at open edges of floors and working platforms to prevent workers from falling



- routes for vehicular traffic. These should be “one way” as far as practicable. Traffic congestion prejudices the safety of workers, especially when impatient drivers unload goods hurriedly;
- storage areas for materials and equipment. Materials need to be stored as close as possible to the appropriate workstation, e.g. sand and gravel close to the cement-batching plant, and timber close to the joinery shop. If this is not practicable, it is important to schedule the arrival of materials;
- the location of construction machinery. This is usually dependent on operational requirements so that tower cranes are subject to constraints such as their radius of operation, and pick-up and unloading

points. The objective should be to avoid the need to slew the load over workers;

- the location of trade workshops – these are not usually moved after they are built;
- the location of medical and welfare facilities. On large sites sanitary facilities for both sexes should be provided at several locations;
- artificial lighting at places where work continues or workers pass after dark;
- site security. The site should be fenced in to keep out unauthorized persons, children in particular, and to protect the public from site hazards. The type of fencing will depend on the location of the site, but in populated areas it should be at least 2 m high and without gaps or holes. Overhead protection will be necessary if tower crane loads pass over public thoroughfares;
- arrangements to keep the site tidy and for the collection and removal of waste;
- the need for low-voltage electric power supplies for temporary lighting, portable tools and equipment;
- training needs of both workers and supervisors.

Point to remember

- The time spent on planning will make for a safer site and save money.

Discussion

- In what ways could you improve on the layout of your site?
- What are some options for sites with problems of limited space?

3.2 Site tidiness

As a worker you can make a major contribution to safe working conditions on site by attention to tidiness. There are many accidents due to tripping, slipping or falling over materials and equipment which have been

left lying around, and stepping on nails which have been left projecting from timber.

Be sure you take the following steps:

- Clean up as you go – do not leave rubbish and scrap for the next person to clear.
- Keep gangways, working platforms and stairways clear of equipment and materials not in immediate use.
- Clean up spilled oil and grease (figure 6).
- Deposit waste material at a recognized disposal point.
- Remove or hammer down any nails you see projecting from timber (figure 7).

Figure 6. Clean up spilt oil or grease



Figure 7. Hammer down any nails projecting from timber

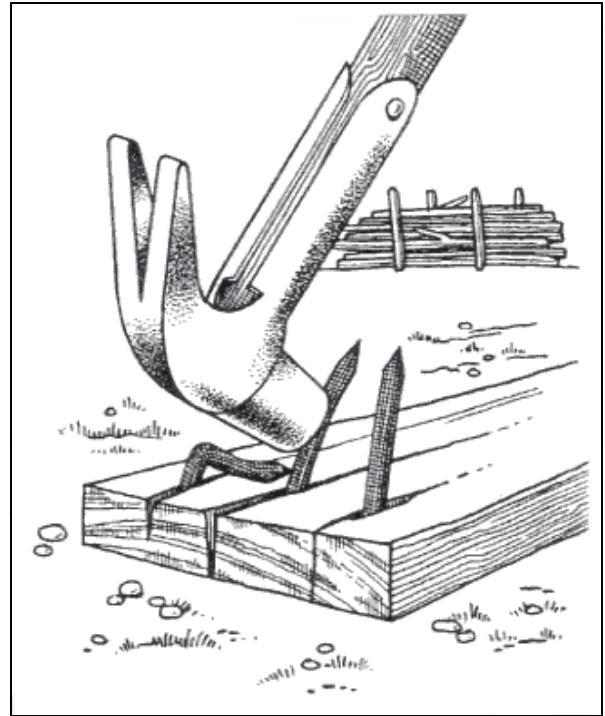

Point to remember:

- An untidy site is a dangerous site.

Discussion

- What are the best ways of disposing of site waste and scrap, and are they followed on your site?
- In what ways could you improve on the tidiness of your site?

4. Excavations

4.1 General measures

4.1.1 Hazards

Most construction work involves some form of excavation for foundations, sewers and underground services. Excavation or trenching work can be highly dangerous and even some of the most experienced workers have been caught by the sudden and unexpected collapse of the unsupported sides of a trench. Buried under a cubic metre of soil you will be unable to breathe due to pressure on the chest, and quite apart from any physical injury you will quickly suffocate and die, for even this comparatively small amount of soil weighs over 1 tonne.

Excavation work involves the removal of soil or a mixture of soil and rock. Water is nearly always present, even if only as moisture in the soil, and heavy rain is a frequent cause of soil slip. The possibility of flooding presents an additional hazard which should always be considered. Cracks are caused by pressure release as soil is removed, or from drying out in hot weather.

Soil varies in its nature (e.g. fine sand which flows easily, and stiff clay which is more cohesive). However, no soil can be relied upon to support its own weight and precautions always need to be taken to prevent the collapse of the sides of an excavation of more than 1.2 m in depth.

4.1.2 Causes of accidents

The main causes of accidents resulting from excavation work are as follows:

- workers trapped and buried in an excavation owing to the collapse of the sides;
- workers struck and injured by material falling into the excavation;
- workers falling into the excavation;

- unsafe means of access and insufficient means of escape in case of flooding;
- vehicles driven into or too close to the edge of an excavation, particularly while reversing, causing the sides to collapse;
- asphyxiation or poisoning caused by fumes heavier than air entering the excavation, e.g. exhaust fumes from diesel and petrol engines.

4.1.3 Safety precautions to prevent the collapse of excavations, and falls

The sides of the excavation or trench should be sloped or battered back to a safe angle of repose, usually 45°, or be supported by timbering or other suitable means to prevent a collapse. The type of support necessary will depend upon the type of excavation, the nature of the ground and the groundwater conditions.

Planning is vital. Make sure that there are enough materials to support the length of the trench to be cut, for the trench support must be installed without delay as the excavation progresses. At least random timbering or piling is required in all excavations, but excavations 1.2 m or more in depth should be provided with adequate timbering or sheeting (figure 8). Close boarding or sheeting is required if the ground is unstable or lacks cohesion. Never work ahead of the trench support.

Shoring should be erected, altered or dismantled only by a competent worker operating under supervision. Wherever practicable, it should be installed before excavating to the final depth of the trench – it is necessary to begin when the trench is less than 1.2 m deep. The excavation and installation of shoring should then proceed by stages until the full depth is reached. You should be fully aware of the procedures to

follow to rescue a fellow worker trapped by a fall of earth.

Figure 8. Shoring to prevent the collapse of the sides of an excavation consisting of timber or steel frames with close boarding between frames

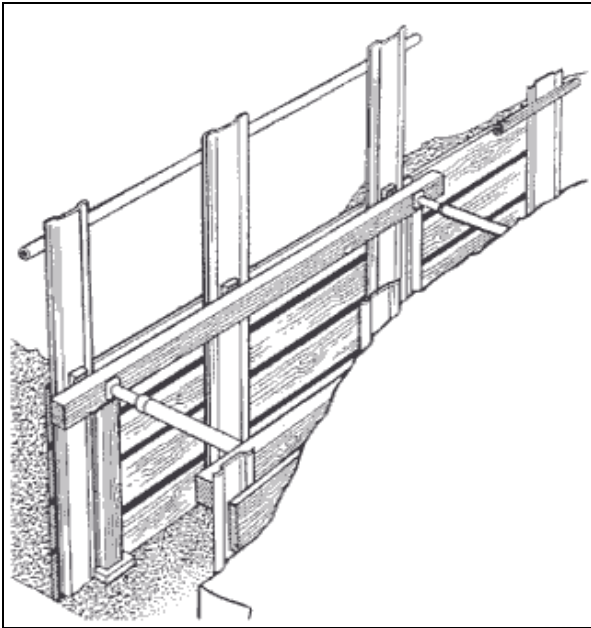

affected by excavation work in progress (figure 10).

Figure 9. Barriers along the sides of an excavation to prevent workers falling into it

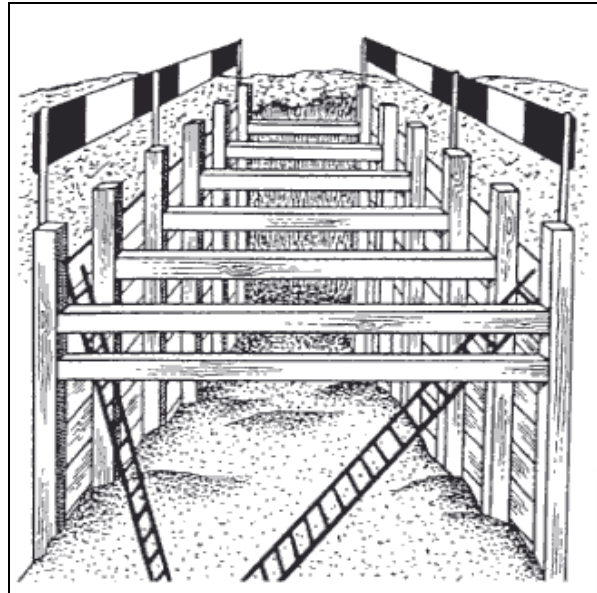

Figure 10. Excavation near a building: Shoring required to prevent collapse of the building

Workers often fall into excavations. Erect suitable barriers high enough (i.e. about 1 m) to prevent falls (figure 9). Projecting trench supports can often be used for this purpose.

4.1.4 Inspection

Excavations should be inspected by a competent person before work begins and at least once a day where work is in progress. They should be thoroughly examined by a competent person once a week and a record kept of such inspections.

4.1.5 Adjoining buildings

Wherever possible, an excavation should not be so close and deep as to undermine any adjacent building or structure. Precautions should be taken by shoring, and so on, to prevent any collapse or fall when the stability of a building or structure may be

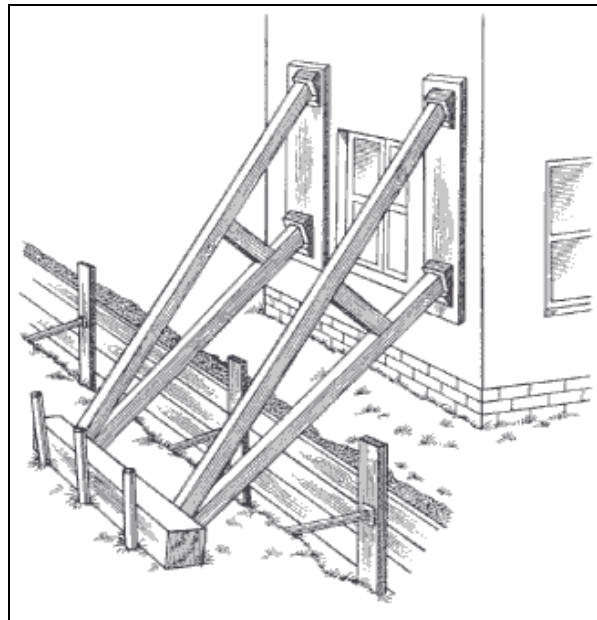

4.1.6 Edges

You should not store, or move, materials and equipment near the edge of an

excavation. Danger may be caused either by materials falling on those working below, or by increased loading on the surrounding ground so as to cause the timbering or supports to the sides of the excavation to collapse. Spoil and waste heaps should similarly be kept well away from the edges of excavations.

4.1.7 Vehicles

Adequate and well-anchored stop blocks should be provided on the surface to prevent vehicles being driven into the excavation while tipping, a particular hazard when reversing (figure 11). The blocks should be placed at a sufficient distance away from the edge of the excavation to avoid the danger

of it breaking away under the weight of the vehicles.

4.1.8 Access

Make sure that there are safe means of access and egress, such as a properly secured ladder, if you are working in an excavation. This is of particular importance when there is a risk of flooding and rapid escape is essential.

4.1.9 Lighting

There should be adequate lighting around the area of an excavation, particularly at access points and openings in barriers.

Figure 11. Stop block to prevent vehicles being reversed into an excavation while tipping

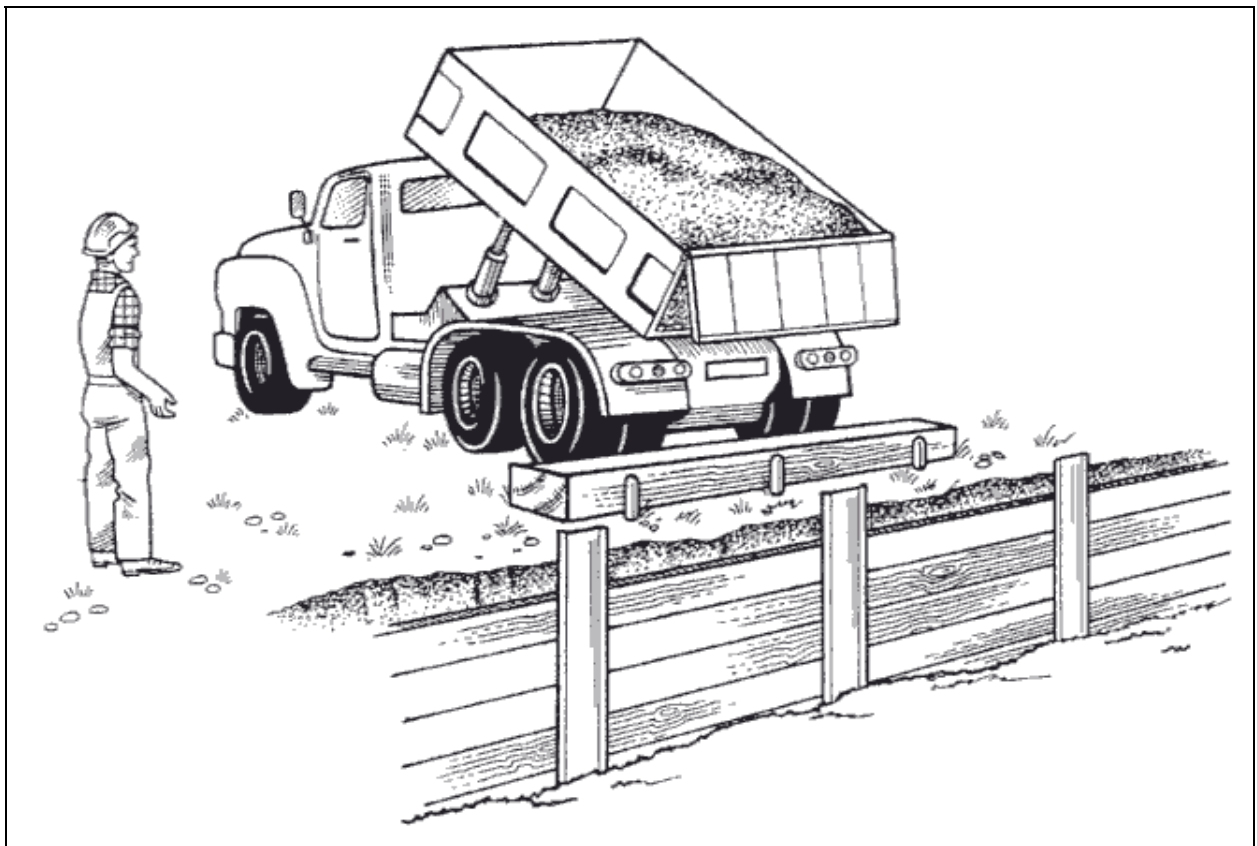

Points to remember:

- Never work ahead of the side supports in a trench even when you are erecting shoring.
- Appearances can be deceptive. The shallowness of an excavation or the solid appearance of the ground are not necessarily an indication of safety.
- Deep trenches look dangerous, but most fatal accidents occur in trenches less than 2.5 m deep.
- Always wear a safety helmet when you work in an excavation.

4.2 Buried or underground services

Before you do any digging, either by hand or with an excavator, remember that there may be underground services below the surface. In built-up areas, always assume that electrical cables, water services and sewers are present. In some locations there may also be gas pipes. Some of these services look alike, so when you find buried services you should always assume the worst. Striking electric cables may cause death or severe injuries by electric shock or severe burns. Broken gas pipes will leak and may cause a fire or explosion. Water and sewer pipes if broken may create sudden risks by flooding an excavation or by causing its sides to collapse.

4.2.1 Electrical cables

Every year workers digging on construction sites suffer severe burns when they accidentally hit live buried electrical cables. Always treat buried cables as live. Before you begin excavating, inquire of the electricity authority, the local authority or the site owner if they have any plans of the layout of cables in the area. Even if plans exist, remember that some cables may not be marked on the plan or may not be exactly

where the plan shows, for cables rarely follow an exact straight line.

Look around for traffic signs, street lights and substations which are usually supplied by buried cables. Use a cable locator if you have one – remember that if cables are close together the locator may not be able to tell them apart. Some types of cable cannot be traced by locators. Once you have found the cable, notify your supervisor and fellow workers. The position of the cable should be marked with chalk, crayon or paint or, if the ground is too soft for this, with wooden pegs (figure 12). Never use sharp spikes. Once the approximate position of a buried cable is known, use hand tools to expose it. Use spades and shovels rather than forks or pick-axes. Keep a careful watch for evidence of cables during digging work. Power tools should not be used within half a metre of a cable.

4.2.2 Other services

As with electricity supplies, inquire of the appropriate authorities and the site owner if plans are available of the layout of gas pipes, water pipes, sewers and telephone cables, and then use similar working methods.

Do not use mechanical excavators within half a metre of a gas pipe. If you smell gas, make sure there are no sources of ignition nearby such as a lit cigarette or running vehicle engine. Keep away from the area, keep other people away and summon the gas authority. Do not use heavy plant or equipment over or near a gas pipe, as the pipe may fracture.

All exposed pipes and cables should be supported when an excavation is open. Do not use them to support equipment or as steps to get in and out of the excavation. Make sure when backfilling a trench with a gas pipe that the fill is adequately compacted beneath the pipe to prevent settlement which could lead to pipe fracture.

Points to remember:

- Hand dig with care, as cables may be just below the surface.
- Use a spade or shovel and not a fork or pick-axe, and do not spear the tools into the ground.
- If you find a cable embedded in concrete, do not break it out but seek advice.
- If a cable is damaged, even slightly, keep well clear.
- Do not work bare chested. Normal work clothing can provide some protection from flash burns.

Discussion

- Outline the precautions that should be taken before anyone is allowed in a trench or excavation.
- What conditions can affect the stability of the sides of an excavation?
- Why are a considerable number of the accidents in excavation work fatal?
- Outline the potential hazards you are likely to meet in a deep excavation.
- If the sides of a trench collapse burying a fellow worker, what action would you take?
- What precautions do you need to take to avoid danger from underground services?

Figure 12. Locating buried electrical cables from a plan and marking their position



5. Scaffolding

5.1 Hazards

Falls of persons from a height, and similarly of materials and objects, represent the most serious safety risk in the construction industry. A high proportion of deaths are caused by falls. Many of the falls are from unsafe working places or from unsafe means of access to working places. This chapter of the manual, and those which follow dealing with ladders and hazardous processes, are aimed at tackling the problem.

Scaffolding can be defined as a temporary structure supporting one or more platforms and which is used either as a workplace or for the storage of materials in the course of any type of construction work, including both maintenance and demolition work. This is the sense in which it is used here.

Where work cannot safely be done from the ground or from the building or structure being worked upon, then there should always be suitable and sufficient scaffolding. This must be properly constructed of sound material which is of adequate strength to provide you with both means of safe access and a safe place of work.

Scaffolds should be erected, altered or dismantled only by competent persons under supervision, and this training manual sets out general principles for the various common types of scaffold. After erection, scaffolds should be inspected at least once a week and a written report on each inspection kept.

There are many different materials used to construct scaffolding, such as steel, aluminium, wood and bamboo. Whatever the material, the principles of safe scaffolding remain the same that it should be of adequate strength to support the weight and stress which the processes and workers will place upon it, that it is securely anchored and stable, and that it is designed to prevent the fall of workers and

materials. The design and erection of tubular metal scaffolding, which is increasingly found worldwide, is taken as the example in this manual.

5.2 Independent tied scaffolds

An independent scaffold consists of a platform resting on horizontal tubes, usually called transoms, which are fixed at 90° to the face of the building and which are secured at both ends to a row of uprights, or standards, and to horizontal tubes, often called ledgers, running parallel to the face of the building. An independent scaffold, although it must be tied to the building or structure, does not rely on it for its strength (figure 13).

The uprights of the scaffolding should be placed on firm and level ground and the base plates at their feet should rest on timber sole boards. These help to ensure that the load carried by each upright is distributed over a fairly large area and so prevents the upright from sinking into the ground and affecting the balance of the scaffold. Never use material which can shatter or move, such as bricks and broken paving stones, as support for uprights.

Uprights should be kept equidistant and should be connected and strengthened by ledgers fixed on the inside of the uprights; for strength, joints in ledgers should be staggered. Transoms should be set on top of ledgers and at right angles to them and the building or structure. Horizontal distances between transoms at working platform level will depend on the thickness of the boards you are using, and which rest on them. For 38 mm thick boards, transoms should be spaced so that no scaffold board overlaps by more than 150 mm (6 in.) or less than 50 mm. Ledgers and transoms should not project more than is necessary beyond the general outline of the scaffold, or they become a danger to pedestrians or passing vehicles. Bracing is

essential to stiffen the scaffold and prevent sideways movement, and it should run diagonally from ledger to ledger or upright to upright. Braces may run parallel to each other

or rise in zig-zag fashion. If bracing has to be removed for the passage of workers and material, this should be only within one lift and it should be immediately replaced.

Figure 13. An independent tied scaffold which does not rely on the building for its strength. It has inner and outer rows of uprights or standards

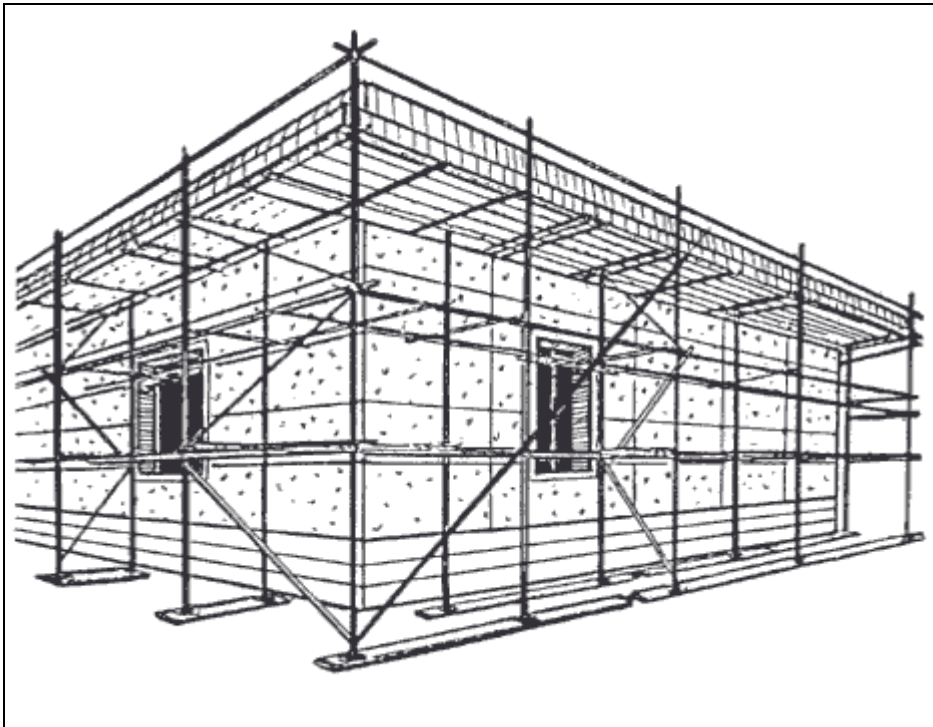

5.2.1 Ties

Make sure that the scaffold is tied or anchored to the building or structure at suitable intervals so as to prevent movement. Remember that the effect of wind is greater on a sheeted scaffold, and can cause a scaffold which is not adequately tied to move away from the face of the building and collapse. Ties may need to be removed in the progress of the work (e.g. for the installation of glazing), but this should be done one at a time with the first tie replaced before the next is removed: it may then be necessary to use a different form of tie. As a rough guide, the area of scaffold per tie should not, generally, be more than 32 sq. m reduced to 25 sq. m for a sheeted scaffold.

5.2.2 Working platforms and gangways

The scaffold boards which make up a working platform should rest squarely and evenly on transoms to prevent the risk of tripping. Where the ends of boards meet, transoms must be doubled and so spaced that no board overhangs by more than four times its thickness. Too much overhang will cause the board to tip if you step on it, while too little – less than 50 mm – will mean that it is easily dislodged. Normally, each board should have three supports to prevent it bending or sagging. The space between the edge of the working platform and the face of the building should be as small as possible. The width of a working platform should be sufficient for the work which is to be carried out from it, and recommended widths are:

- not less than 60 cm if used as footing only;
- not less than 80 cm if used also for the stacking of material;
- not less than 1.1 m if used for the support of a trestle platform.

Gangways or runs should be of adequate width for their purpose and should preferably be horizontal. If the slope exceeds 20°, or the surface is likely to become slippery with rain, laths should be fixed at 90° across the slope, allowing a small central gap to accommodate wheelbarrow wheels. Finally, precautions must be taken to prevent boards lifting in high winds.

5.2.3 Guard-rails and toe boards

The provision of secure guard-rails and toe boards at every point at which you may fall more than 2 m is critical if falling accidents are to be prevented. Both should be fitted on the inside of the uprights. Guard-rails should be between 90 cm and 115 cm above the platform to prevent you from easily falling over or under the rail. Toe boards, which are also intended to prevent material being knocked over the edge of the platform, must rise at least 15 cm above the working platform to achieve this, and if materials are stored to greater than this height then additional boards may be necessary or the space filled in with wire mesh (figure 14). If guard-rails and toe boards are removed for the passage of materials, replace them as soon as possible.

Figure 14. Working platform showing guard-rail and toe board with wire mesh filling between them and the closely boarded platform

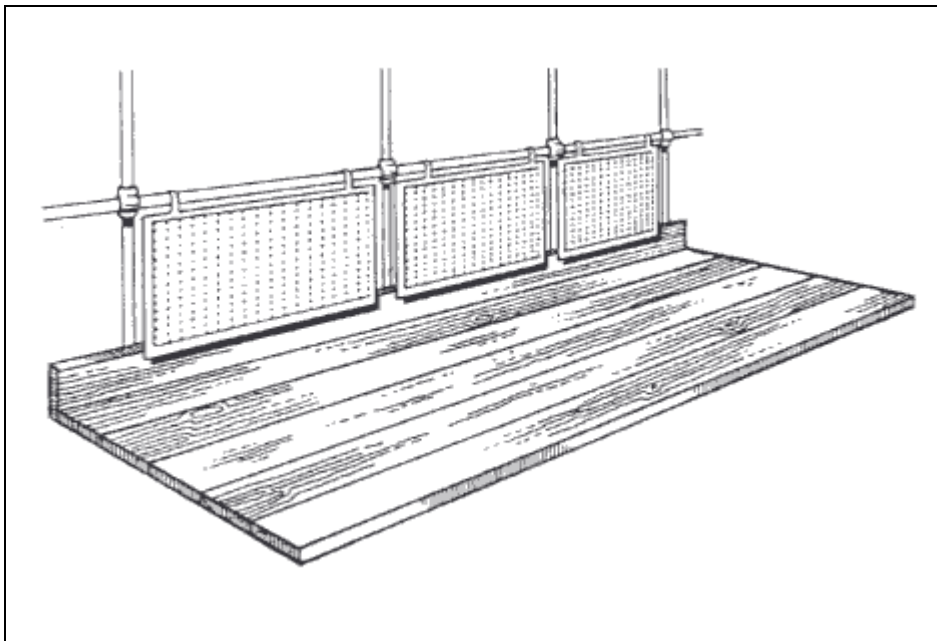

5.3 Single pole or putlog scaffolds

A common type of scaffold for smaller jobs is a single pole or putlog scaffold which consists of a platform resting on horizontal putlogs (called transoms in independent

scaffolds) fixed at 90° to the face of the building (figure 15). The outer ends of the putlogs are supported on horizontal ledgers fixed parallel to the face of the building and

secured to a single row of uprights or standards, also parallel to the wall. The flattened inner end of the putlogs rests flat on the wall, or in holes in the wall, rather than on ledgers. It follows that the scaffold cannot stand without the support of the structure. Putlog scaffolds are mostly used where brick structures are being built. The same principles of good construction as for independent scaffolds are generally applicable.

A good base for the single row of uprights is essential and the base plates for each upright should again rest on a timber sole board – a sole board should be long enough to support at least two uprights. The uprights should be not more than 2 m apart and set at 1.3 m from the wall to allow for a five-board platform. Ledgers should be connected on the inside of the uprights, at a vertical distance of not more than 2 m – a lesser distance may be necessary for some types of work – and left in position as the scaffold rises.

Putlogs should rest on and be secured to the ledgers at horizontal gaps depending on the thickness of the boards used – of not more than 1.5 m for boards of 38 mm – while their flattened, or spade, ends should lie on the brickwork, or enter the wall to a depth of at least 75 mm. For repointing old brickwork, the spade ends can rest vertically in joints in the brickwork. Tying into the building is of even greater importance than with independent scaffolds, as putlogs can easily work loose in brickwork. In this type of scaffold, bracing along the face and to the full height of the scaffold is required. Bracing should be at an angle of about 45° to the horizontal and at 30-metre intervals. The requirements already described for the construction of working platforms and gangways and for the erection of guard-rails and toe boards apply equally to putlog scaffolds.

Figure 15. A single pole or putlog scaffold, with a single outer row of uprights or standards and which is partly supported by the building

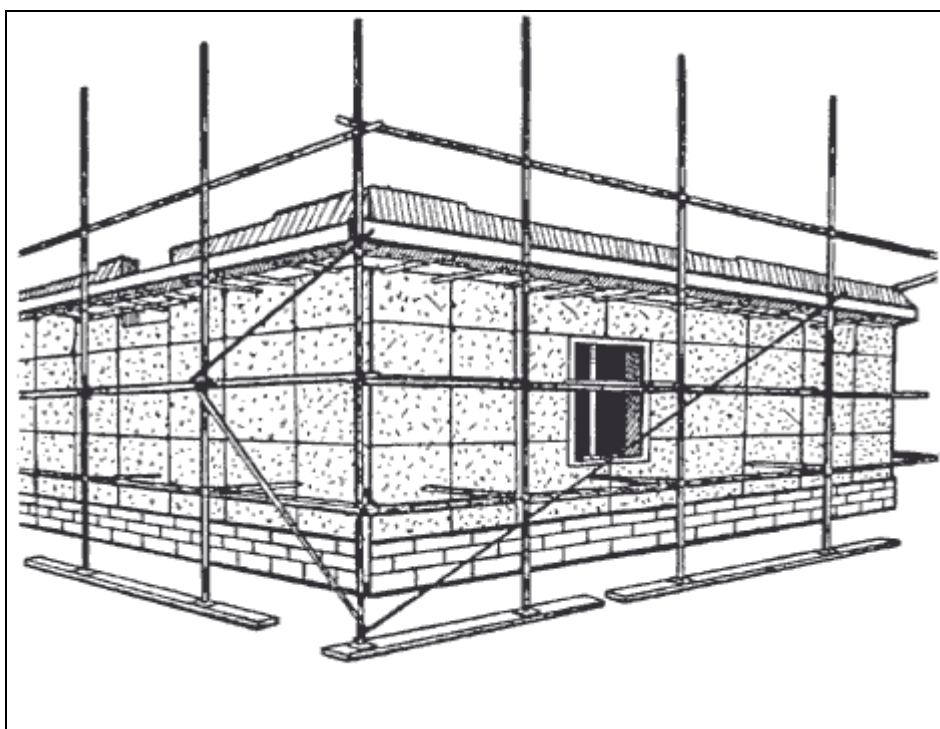

A scaffold should not be left partly constructed or dismantled unless adequate notices warning against its use are displayed and all points of access are blocked off.

With both types of scaffold, there is often a need to provide sheeting, boarding, netting, fans or brickguards to prevent materials falling from the scaffold into the street or public places (figure 16). Scaffolding is often easily accessible from the street and positive steps such as the removal of access ladders should be taken to prevent children climbing a scaffold, particularly after the close of the working day.

Figure 16. Protection of scaffold from falling materials – scaffold fan and debris netting

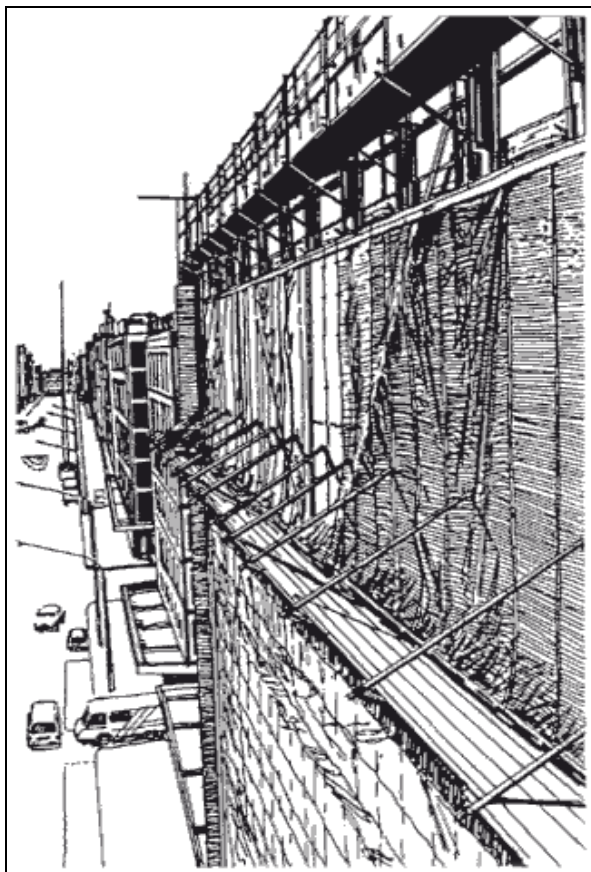

Points to remember

- Where you cannot work safely from the ground or from part of the building, it is better to use a suitable scaffold than a ladder.
- Use a scaffold only for the purpose for which it has been provided and make sure it is securely anchored or tied to the building.
- Do not overload the scaffold. In particular, do not load it with plant and materials unless it has been erected for this purpose. Never keep materials on the scaffold unless they are needed for work within a reasonable time.
- Make sure that timber used in scaffolding is not painted or treated so that defects cannot be seen.
- Do not use bamboo that show signs of rotting or being infested by insects; also examine the ropes for early signs of decay, avoid using material about which there is doubt.

5.4 Tower scaffolds

A tower scaffold consists of a platform resting on horizontal ledgers connected to four uprights, supported on base plates if static or on castor wheels if mobile (figure 17). It is devised for painters and others who do lightweight work of limited duration mainly in one place.

5.4.1 Causes of accidents

Accidents can happen when a tower topples over. This is likely to happen in any of the following cases:

- the ratio of the height of the tower to the width of the base is excessive;
- the top working platform is overloaded causing the tower to become unstable;

Figure 17. Mobile tower scaffold-wheels should be locked when in use; ladder access should be inside the tower

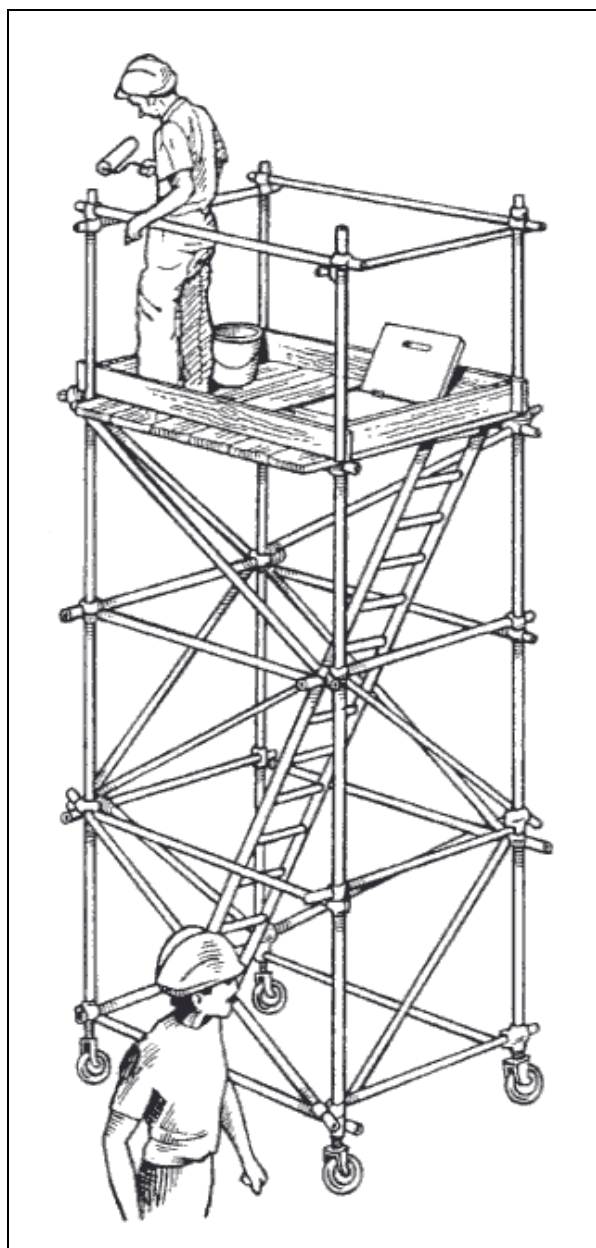

- a ladder is placed on the top platform to extend the height of the tower;
- work involving percussion tools produces an outward horizontal or lateral force at the top of the tower;
- a mobile tower is moved with persons or materials carried on the top platform;
- the tower is used on sloping or uneven ground;

- the tower is not tied to the building or structure where this is necessary;
- access to the platform is via the outside of the tower.

5.4.2 Height limitations

The first precaution with tower scaffolds is to achieve stability. For this the ratio of height to base width should not be more than 4:1 for a static tower which you are using indoors. For a static tower used outdoors the ratio is reduced to 3.5:1, while for a mobile tower used outdoors it should not be more than 3:1. Any loading on the platform will raise the centre of gravity of the tower and too great a load will endanger its stability.

Static towers should not exceed 12 m in height when free-standing, and above this height they should be tied. Mobile towers should not exceed 9.6 m in height when free-standing or 12 m when tied to a structure.

5.4.3 Structure

Towers should be vertical, have a single platform and be used only on a firm and level base, with the uprights of static towers on adequate base plates. Dimensions will vary according to need but corner standards should never be less than 1.2 m apart. The uprights of mobile towers should have castor wheels of not less than 125 mm in diameter which are locked into the base of the uprights. The castor wheels should be fitted with locks or brakes which cannot be accidentally released, and you should ensure that the brakes are applied whenever the tower is stationary.

5.4.4 The working platform

The platform should be equipped with a cover for the ladder access opening which is able to be fixed in both open and closed positions with a latch. This prevents an accidental step into the opening. The cover should be provided with a suitable handhold to provide support when you are climbing through the opening. Guard-rails and toe

boards will be necessary for the sides of the working platform, erected as for independent scaffolds. The ladder provided for access to the working platform should be positioned inside the tower as a precaution against overturning (figure 17).

5.4.5 Movement

Never move a mobile tower with persons or materials on the working platform. Move the tower by pushing and pulling at the base and not by towing with a vehicle.

Points to remember:

- Tie the tower into the adjacent structure wherever possible.
- Use the locks on the wheels whenever the scaffold is in use.
- Never climb a mobile scaffold unless the wheels are locked and on level ground.
- Keep the material on the platform to a minimum.
- Keep towers away from overhead electrical supply lines and check that mobile towers are free of overhead obstructions before moving them.
- Avoid using a tower in windy or severe weather conditions.

should not be used for scaffolds of more than two tiers in height, and where the working platform is more than 2 m high guard-rails and toe boards should be provided. Trestle scaffolds are not suitable for work situations where a person is liable to fall a distance of more than 4.5 m from the platform.

As with the other types of scaffold, trestle scaffolds should be set up on a firm and level base and firmly fixed so as to prevent displacement. Make sure the trestles are adequately braced to ensure rigidity and to resist lateral movement. Trestles should be no more than 1.35 m apart when boards 38 mm thick are used, and 2.45 m apart if 50 mm boards are used. Wider spans are possible if proprietary staging is used and such staging is generally preferable to scaffold boards.

Inspect the trestles before use and reject them if they have defective components such as loose or damaged crossbearers, broken or damaged hinges including missing screws or bolts, or damaged or split stiles.

Points to remember:

- Never use odd lengths of board to make up the working platform.
- Always sit to work if you can do so.

5.5 Trestle scaffolds

Trestle scaffolds are simply working platforms supported on “A” frames or a similar type of folding support.

Remember that trestle scaffolds, whether the trestles be fixed or folding in type, should be used only for light work of comparatively short duration (figure 18). Folding trestles should be used only for scaffolds of one tier in height, and the working platform should be at least 430 mm (two scaffold boards) wide. One-third of the height of the trestles should be above the working platform. Fixed trestles

Figure 18. A trestle scaffold suitable only for light work such as cleaning or painting

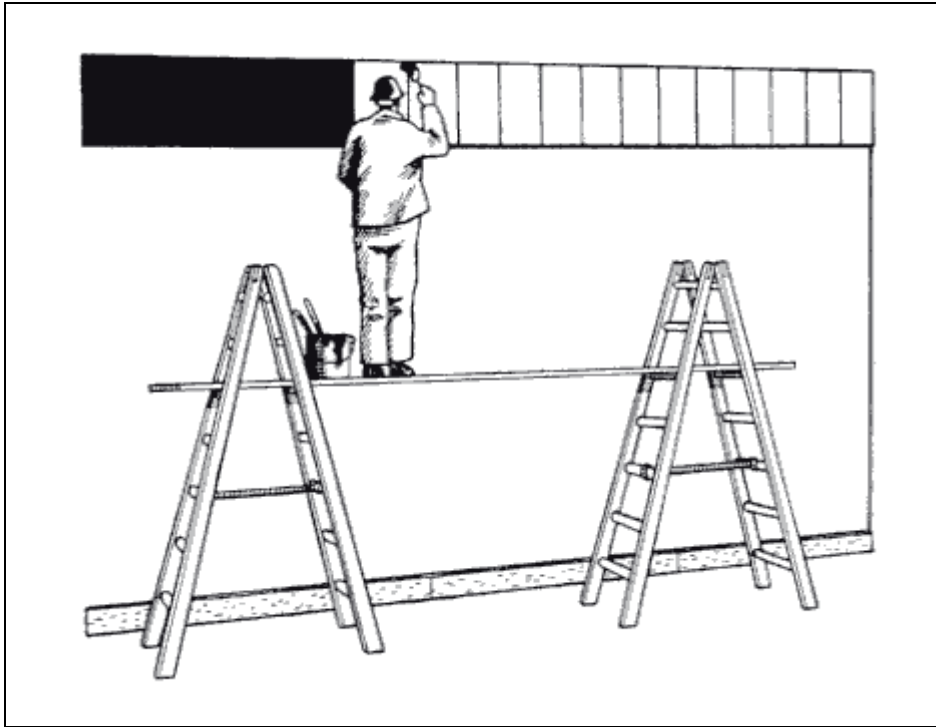

5.6 Suspended scaffolds

Suspended scaffolds are used most frequently for work on tall buildings or structures above busy streets, or in other situations where it is not feasible or economic to build a scaffold from the ground. Suspended scaffolds are of two main types:

- suspended platforms, hinged or independent;
- cradles.

All are suspended from the building or structure by means such as outriggers, tracks and parapet hooks.

Typical accidents on all types of suspended scaffold occur because of:

- difficulty getting in and out of the suspended cradle;
- insufficient or poorly secured counterweights;

- failure of suspension ropes;
- poor maintenance.

5.6.1 Access to the scaffold

Normal access should be at either ground or roof level. If at roof level the guard-rail of the platform (or cradle) should be at roof or parapet level and only one person at a time should enter or leave the platform.

5.6.2 Suspension ropes

To safeguard against the consequences of a rope failure, a fall arrest device operating on a secondary safety rope should be used. All ropes should be thoroughly examined by a competent person at least once every six months.

5.6.3 The platform

The working platform or cradle should be inspected before each use and at least once a week. The safe working load should be clearly marked on it.

5.6.4 Erection and training

Whatever type of suspended scaffold is used, the services of a competent person able to supervise construction and subsequent use is required. Erection should be carried out only by an experienced person. The only people who should work from a suspended scaffold are those who have been trained in the use of the equipment and of its safety devices, and who are aware in practical terms of its safe working load and of emergency procedures. Remember that if you work on a suspended scaffold you should always wear an approved safety harness with a lifeline securely attached to the building.

Points to remember:

- Do not work on a suspended scaffold unless you have been trained to do so.
- Never climb up or down the suspension ropes to get into or out of the scaffold or cradle.

Discussion

- What do you understand by the term “scaffold”?
- When should a scaffold be provided instead of a ladder?
- What considerations should be given to providing safe means of access for workers and materials?
- What is the difference between a single pole (or putlog) scaffold and an independent scaffold?
- What are the main causes of accidents arising from the use of such scaffolds and what precautions can be taken?
- How do you ensure that the integrity of a scaffold is maintained throughout its use?
- What precautions are necessary to ensure the stability of tower scaffolds?
- From your own experience, what unsuitable and unsafe scaffolding have you seen being used, what were the potential dangers and what steps should have been taken to remove the hazards?

6. Ladders

Every year many workers are killed or severely injured while using ladders of all types. Because a ladder is so readily available and inexpensive, its limitations are easily overlooked. So the first question to ask is – can the job be done more safely using other equipment? For example, a proper working platform can often ensure that the job is performed more quickly and efficiently.

6.1 Limitations

If you are thinking of using a ladder, remember that if properly used it:

- enables only one person to climb or descend at any one time;
- enables only one person to work from it at any one time;
- if not lashed at the top, requires two workers for use – one on the ladder and the other at the bottom;
- leaves only one hand free; carrying tools or loads up a ladder is difficult and dangerous and the weight which can be carried is severely limited. There is also the risk of dropping items on passers-by;
- restricts movement;
- has to be safely situated and secured;
- has a limitation on heights at which it can be used.

6.2 Secure your ladder

More than half of ladder accidents are caused by the ladder slipping at the base or at the top. So make sure that you stand the foot of your ladder on a firm and level base. Never wedge one side of the ladder up if the ground is uneven. If possible, level the ground or bury the foot of the ladder. If the ground is soft, put down a board. Never support the ladder by carrying its total weight on the bottom rung – only the stiles or side members are meant for this.

The head of the ladder should rest against a solid surface able to withstand the loads imposed on it; otherwise use a ladder stay. Whenever practicable, tie or lash your ladder at the top – someone should hold the ladder at the foot while you do so (figure 19). If this is impracticable, secure the ladder at the bottom by tying it to stakes in the ground or by using sandbags (figure 20). If neither is practicable, a fellow worker should be at the foot of the ladder to prevent it slipping while you are working from it, but this precaution is only effective if the ladder is not more than 5 m in length. Your fellow worker should face the ladder with a hand on each stile and with one foot resting on the bottom rung. The use of non-slip pads on ladder feet helps to prevent ladders slipping at the base.

Point to remember:

- Make sure your ladder is lashed or footed before you climb it

Figure 19. Ladder secured at its upper end, extending above the landing place

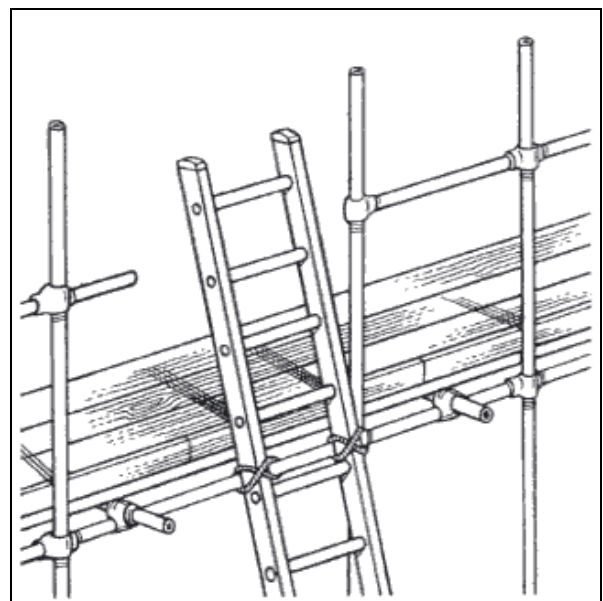
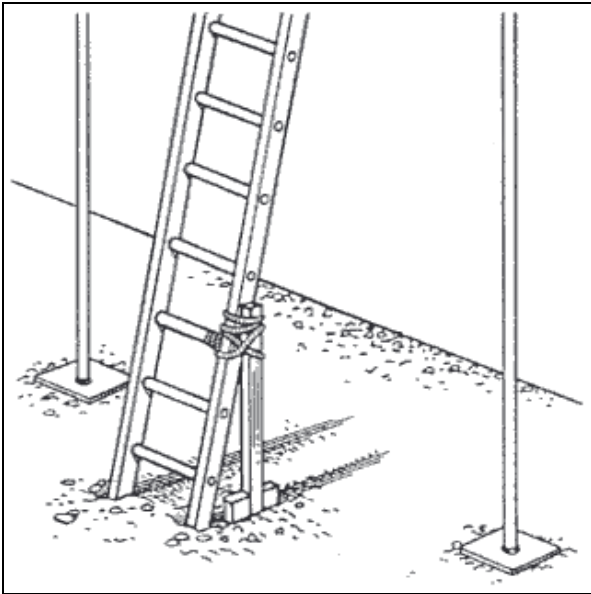

Figure 20. Ladder secured at its foot to stop movement



6.3 Safe use of ladders

Safe use means observing the following precautions:

- make sure there are no overhead power lines with which the ladder might make contact;
- wooden ladders with wire-reinforced stiles should be used with the wired side facing away from you. Wire tie rods should be beneath and not above the rungs;
- the ladder should extend at least 1 m above the landing place, or above the highest rung on which you have to stand, unless there is a suitable handhold to provide you with equivalent support (figure 19). This is to stop the risk of over-balancing when you step off and on at the top;
- you should be able to step off the ladder at the working place without being required to climb over or under guard-rails or over toe boards. However, keep the gaps in guard-rails and toe boards as small as possible;
- never use a ladder which is too short, and never stand it on something such as a box, bricks or an oil drum to gain extra height;

- place the ladder at a safe angle of about 75° to the horizontal, that is about 1 m out at the base for every 4 m in height;
- face the ladder when climbing or descending;
- ensure that there is sufficient space behind the rungs to provide a proper footing;
- for extension ladders, make sure you leave an overlap of at least two rungs for sections up to about 5 m in length and at least three rungs for sections of more than 5 m in length (figure 21);
- always raise and lower extension ladders from the ground and make sure that hooks or locks are properly engaged before you start to climb;
- make sure that your footwear is free from mud or grease before you begin to climb a ladder;
- if possible carry your tools in your pockets or in a holster or bag when you climb ladders so as to leave both hands free to grip the stiles (figure 21);
- try not to carry materials while you are climbing ladders – use a hoist line instead;
- a common cause of accidents is overbalancing or overreaching, so do not be tempted to stretch too far (figure 21); instead move the ladder.

Points to remember:

- Make sure that your ladder is long enough for the job.
- Avoid carrying tools or materials in your hand while you are climbing ladders.
- Clean your footwear before climbing.

Figure 21. Safe use of ladders – allow sufficient overlap of extension-ladder sections; carry tools safely; don't overreach

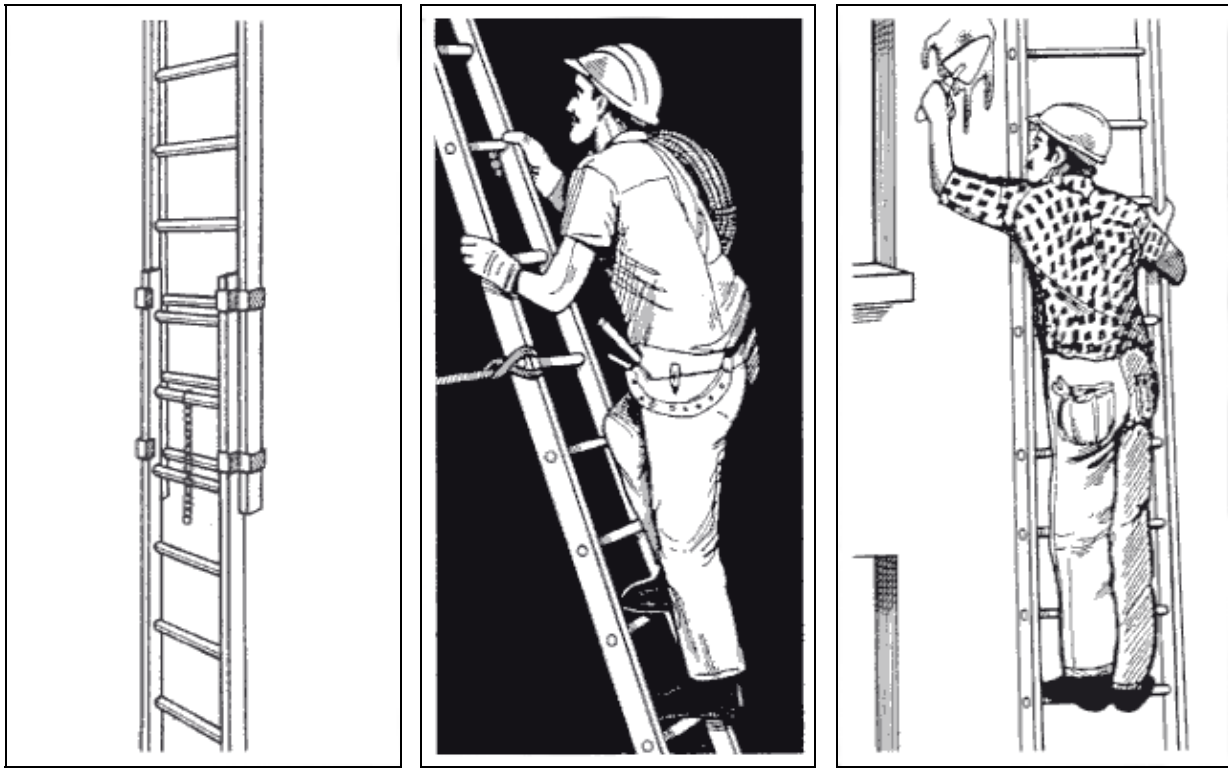

6.4 Care of ladders

Proper care of ladders involves the following measures:

- ladders need to be inspected regularly by a competent person and damaged ladders removed from service. Timber ladders should be checked for splits or cracks, splintering or warping, metal ladders for mechanical damage. Look for missing, loose or worn rungs;
- ladders should be capable of being individually identified, e.g. by some form of marking;
- ladders not in use should not be left on the ground so that they are exposed to weather water and impact damage. They should be properly stored on racks under cover and above ground, and ladders over 6 m in length should have at least three support points to avoid sagging;
- a ladder should not be hung from its rungs or from one stile as this tends to pull out the rungs;
- timber ladders should be kept in areas with good ventilation which are free from excessive heat or dampness;
- timber ladders and equipment may be coated with transparent varnish or preservative, but should not be painted as paint conceals defects;
- aluminium ladders should be given an adequate protective coating when they are likely to be subject to acids, alkalis or other corrosive substances.

Points to remember:

- Always inspect your ladder before you use it.
- Remove damaged ladders from use and make sure that they are properly repaired. If they cannot be properly repaired, they must be destroyed.

Discussion

- What are the advantages and disadvantages of using ladders?
- For what sort of work are they best suited?
- What are the most common causes of ladder accidents?
- What procedures should you follow to take care of ladders?
- What precautions should you take in using stepladders?

6.5 Stepladders

Stepladders should be spread to their fullest extent and used on a level surface. They should be placed at right angles to the work whenever possible. Work should not be carried out from the top platform or tread of a stepladder unless there is an extension to provide an adequate handhold.

The strings, chains or cords used to prevent stepladders from spreading should be of sufficient and equal length and kept in good order. If you use a stepladder in a doorway, make sure the door is wedged open.

7. Hazardous processes

7.1 Roof work

Without proper precautions, roof work is among the most hazardous of construction operations. The most common accidents to workers are due to:

- falls from the edge of roofs;
- falls through openings in roofs;
- falls through fragile roof materials.

Although most accidents happen to specialist roofworkers, there are many workers engaged simply in maintaining and cleaning roofs. To undertake roof work safely you require knowledge and experience, and special equipment. Before the job begins, a safe system of work must be planned. Precautions must be adopted to reduce the risk of a worker falling or, if it occurs, to prevent the fall being the cause of serious injury. The precautions to be taken will depend on the type of roof and the nature of the work to be undertaken.

7.1.1 Flat roofs

Flat roofs include those with a pitch of up to 10°. All the edges and openings on a roof from or through which there is a possible fall of more than 2 m should be protected with suitable guard-rails and toe boards erected to the same standard as described in Chapter 5 for scaffolding (figures 22 and 23). In the case of openings, the alternative is to provide a substantial cover which will bear your weight, and which is not easily moved. It must be boldly and clearly marked as to its purpose. If there is an upstand at the edge of the roof of sufficient strength, conventional scaffold tubes to support guard-rails and toe boards can be attached to this. Alternatively, a system of simple precast counterweights can be used to support edge protection, or a series of triangular tubular steel frames approximately 2.4 m apart and using conventional scaffold tubes can be anchored to the roof, again by precast concrete counterweights.

Figure 22. Edge protection for flat roof – diagram of what is required

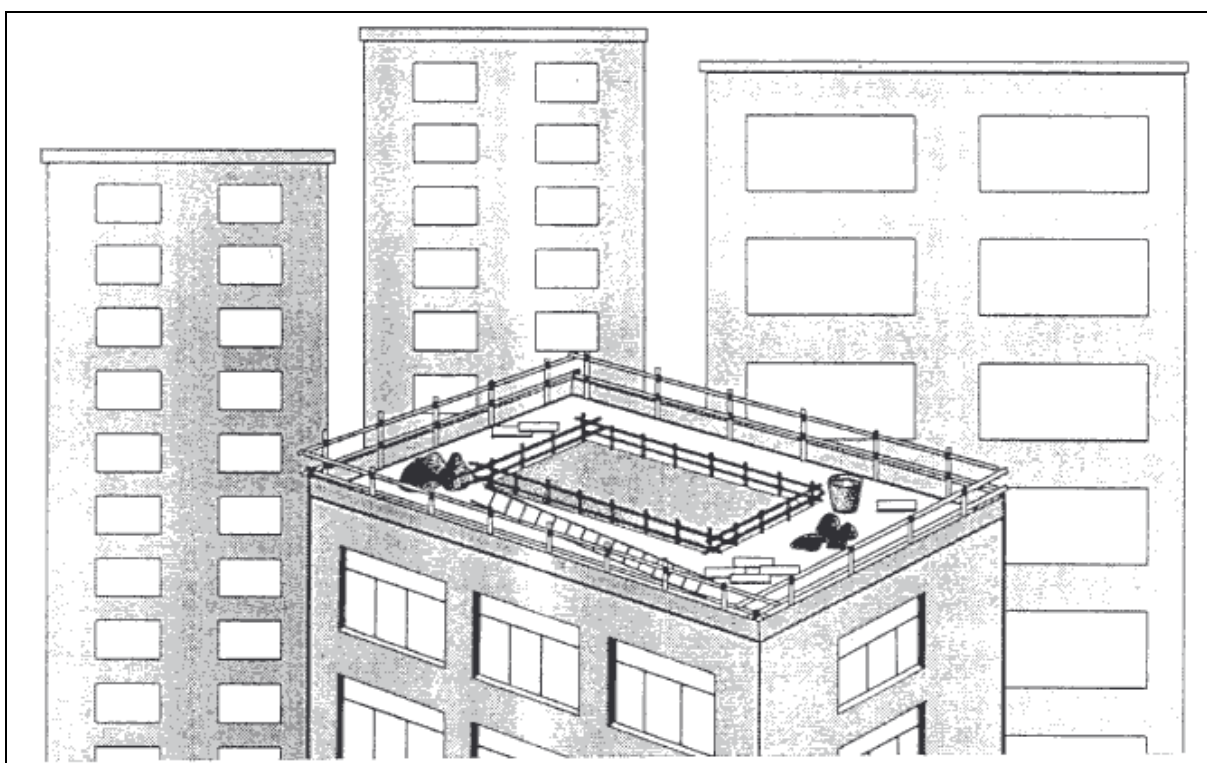
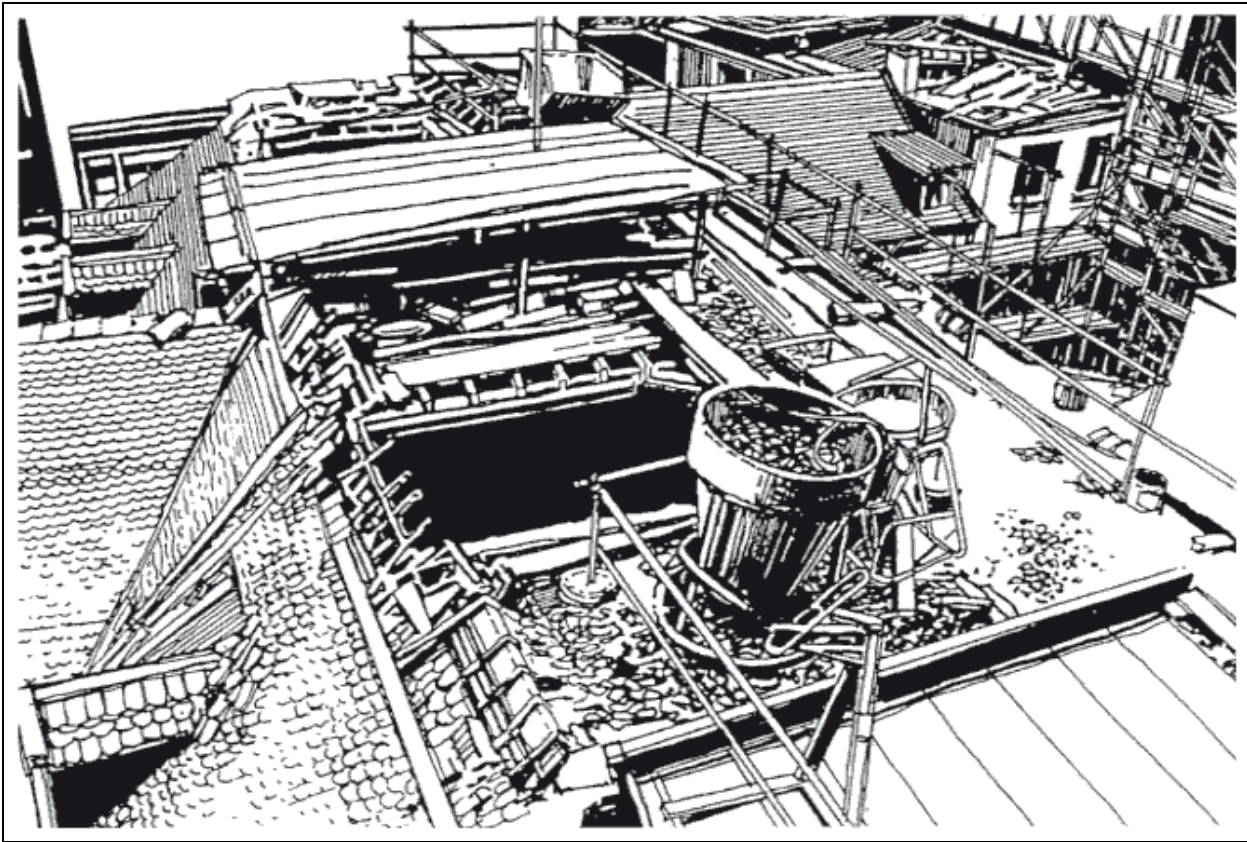

Figure 23. Edge protection for flat roof – a real-life example



7.1.2 Sloping roofs

Edge protection is necessary for all sloping roofs, that is of more than 10° pitch, or which have a slippery surface and where there is the possibility of a fall of more than 2 m from the edge of the roof. It should take the form of barriers or guard-rails high enough and strong enough to stop you if you are rolling or sliding down the roof slope (figure 24). The roof surface may be slippery because of the material from which the roof is constructed or because of the growth of moss or lichen, or it may quickly become slippery after rain or snow.

Unless tile battens on a roof are of adequate strength and themselves provide adequate handholds and footholds, you should use purpose-made crawling ladders or crawling boards (figure 25), even for inspection or work of short duration.

7.1.3 Fragile roofs

Before you use any roof as a means of access or a place of work, make sure that no part is covered with fragile material. Some roof coverings give a false sense of security and the impression of a surface which is solid enough to bear your weight, but they will not carry a concentrated load such as that applied by the heel of your foot, or if you stumble or fall. A common example is single-thickness asbestos cement sheeting which may shatter without warning. Do not make the common mistake of believing that it is safe to walk along the lines of sheeting bolts. Other examples of fragile material are wired glass, corrugated plastic sheeting for roof lights, rusted corrugated iron sheeting and unreinforced insulating slabs. Sometimes fragile materials are not easily recognizable beneath a paint or tar covering, particularly when they have been used to patch or repair a roof.

Once fragile material has been identified, or if you are in any doubt, use at least two crawling boards or roof ladders, so that one is available to stand on while you are moving the other.

Special precautions are necessary where a valley or parapet gutter is used as a means of access and the adjacent roof is covered with fragile material. Covering, or guard-rails, should be provided to prevent you from falling through if you slip or stumble. Prominent warning notices should be displayed at the approaches to fragile roofs.

Points to remember:

- Never work on a roof which is without adequate edge protection.
- Before you work on a roof make sure you know which parts are made of fragile material.
- Never step on to a fragile roof.

Figure 24. Sloping roofs: Two methods of providing edge protection

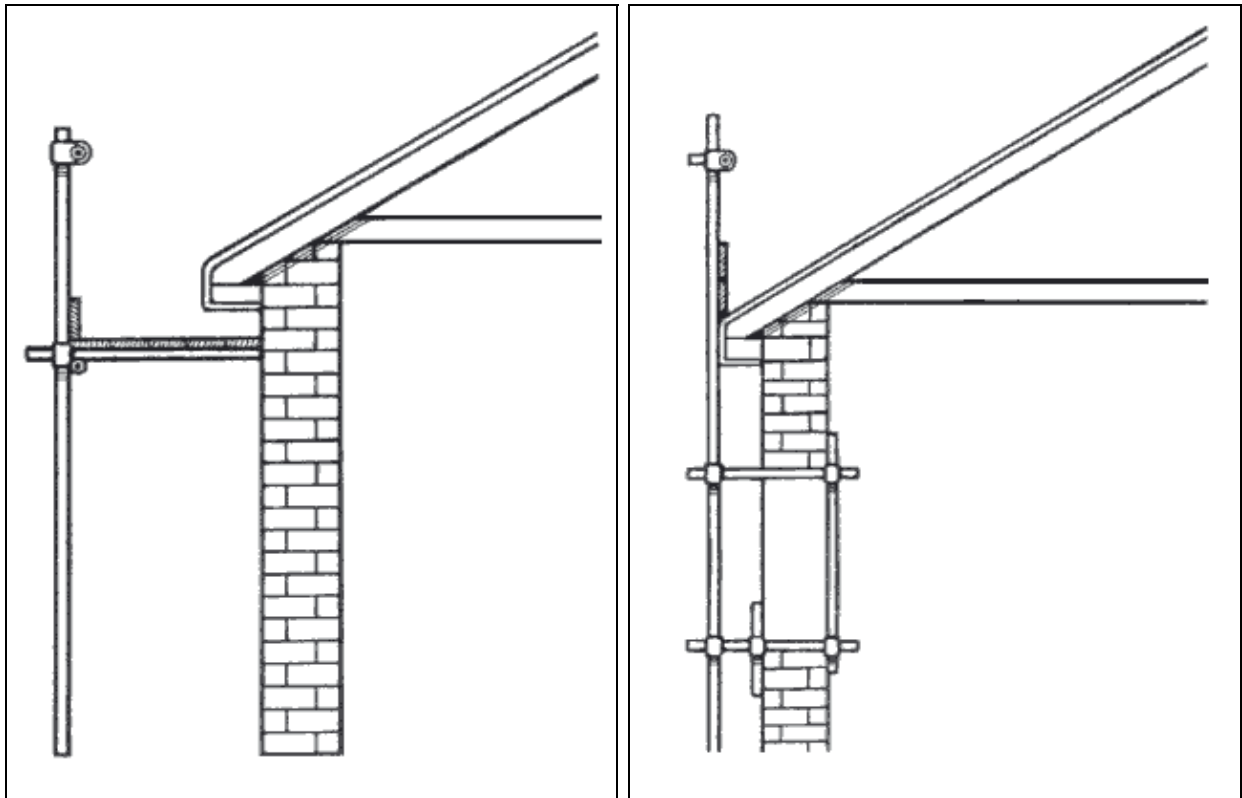

7.1.4 Crawling boards and roof ladders

Crawling boards and roof ladders (figures 25 and 26) should be properly designed and constructed, and not made up from odd timber found at the site. Boards should have cross battens at least 32 mm thick and not more than 380 mm apart, and should be secured in position.

The ridge anchorage or ridge iron at the top of the board or ladder should not rely for support on the ridge capping which is liable to break away, but should bear on the opposite slope of the roof or be secured by a rope. Eaves gutters should not be used as a footing or to support a roof ladder, as they are not strong enough.

Discussion

- What types of accident are most associated with roof work?
- What are the precautions you need to take to prevent them?
- Describe ways of providing protection against falls from the edges of roofs.
- What are the characteristics of a good crawling board or roof ladder?

Figure 25. Roof ladder for work on a sloping roof or over fragile materials

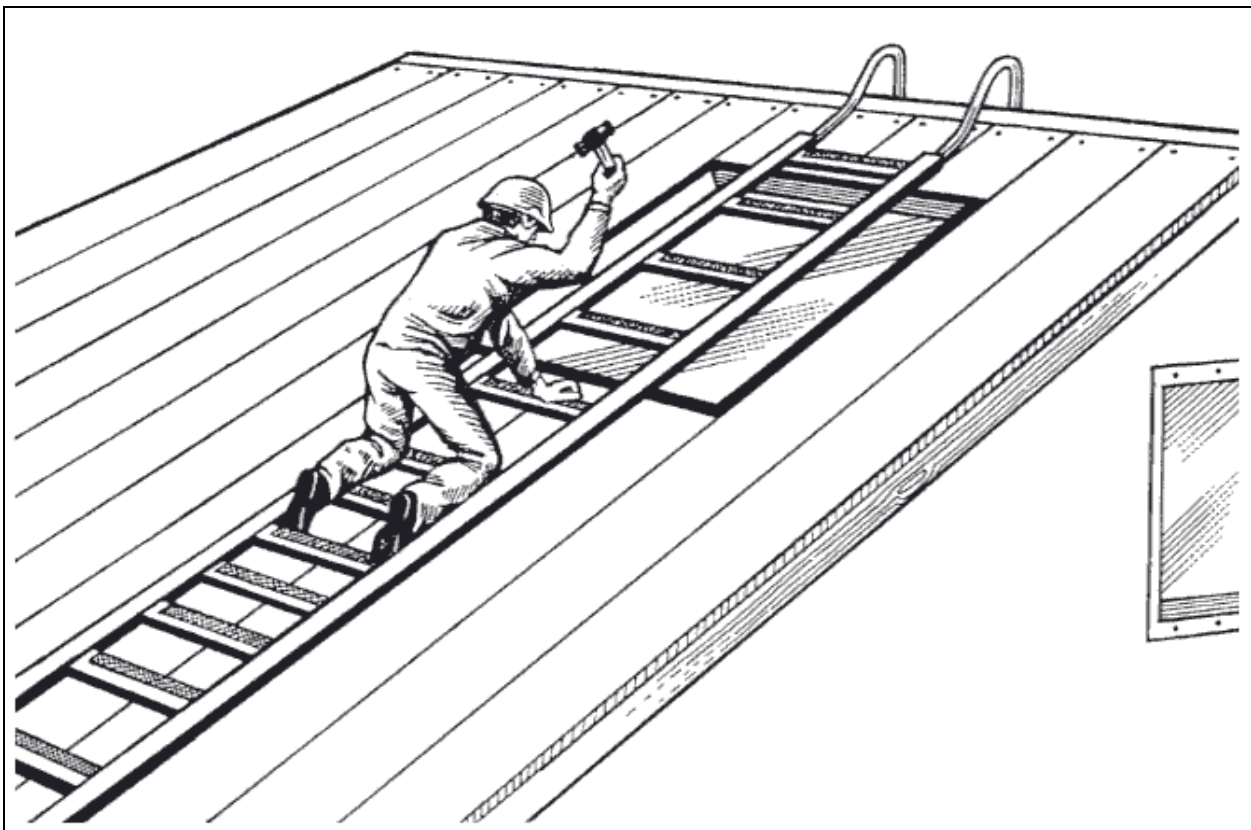
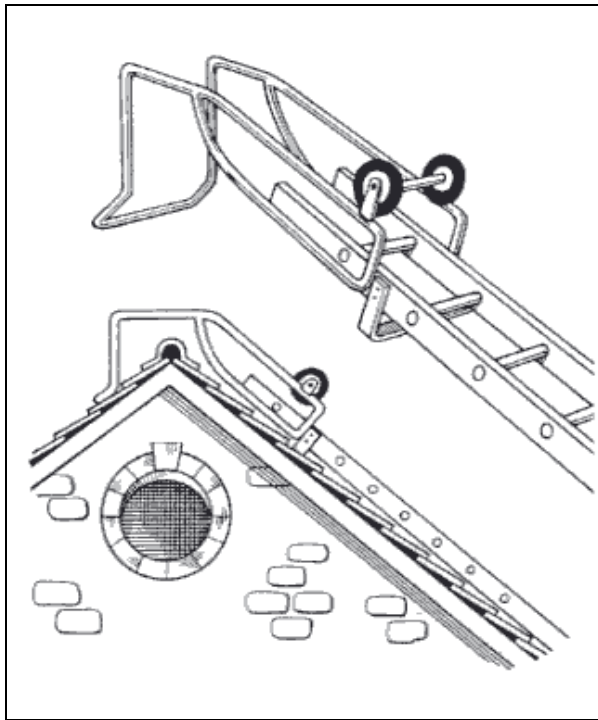

Figure 26. Roof ladder with ridge iron to place over roof ridge



7.2 Steel erection

The erection of steel structures and building frames involves work at heights and in exposed positions. The incidence rates for injury and death of steel erection workers are much greater than those for workers in the construction industry as a whole, high as these are.

Because the time spent at individual workpoints is often relatively short, access scaffolding is frequently not used and steel erectors perform many tasks in unnecessarily dangerous situations, often from a mistaken belief in their own invulnerability.

7.2.1 Design planning

If you work in steel erection you should know what safety precautions should always be taken before you begin work on site. It is essential that safety in steel erection begins at the design stage. Designers of structural steelwork should have sufficient site experience to understand fully the problems of

steel erection, such as joint positions affecting erection sequences, the accessibility of connections, fixings for working platforms, and means of access and weights in relation to crane capacity. Designers should provide sufficient information so that the erection contractor is aware of the precautions which need to be taken to ensure the stability of the steelwork during erection. The contractor in turn should provide a statement of the proposed erection method and submit this to the designer for acceptance. A safe method of work includes the identification of hazards and difficulties which could lead to departures from the planned sequence of erection.

7.2.2 Supervision

Because fabricators and erectors of structural steelwork are often from different companies, there is the need for a supervisor from the main contractor to ensure that all procedures, checks and inspections are carried out, including clearance of any modifications or changes introduced.

7.2.3 Work preparation

Because erection of steelwork usually takes place during the early stages of a project before the site has been cleared and prepared, arrangements for the storage and handling of prefabricated steelwork are frequently haphazard, and there is often no proper access and freedom of movement for transport and cranes. Prior construction of ground-floor concrete slabs, access roads and hardstandings will encourage the use of cranes, tower scaffolds and mobile platforms, and provide a cleaner and safer site. The layout of the storage area for steelwork and materials needs to be arranged so that vehicles and cranes can move about without fear of collision.

To assist in safe lifting and movement of structural steelwork by crane, or by guy and pole derricks where cranes cannot be used, there should be clear indications of the weight of components and, wherever possible, markings giving suitable slinging points. Use

should be made, wherever practicable, of hand lines attached to any item being moved.

The weather should be constantly monitored in relation both to wind and rain. There is danger in using cranes in high winds, and in working on steelwork in high winds and on wet surfaces.

Holding-down bolts are usually provided and fixed before the steel erectors arrive, and their importance is often underestimated. Errors in position, alignment and level can lead to improvisation, and careful checking is necessary before erection begins. During the early stage of construction, excess loadings can be applied to the bolts and there is a danger of collapse unless adequate temporary bracing is provided in the form of props or guys. Many of the collapses which occur are caused either by failing to use adequate bracing, or by departing from planned arrangements to ensure stability. Erection planning should include the provision of sufficient guys, props, bracings and temporary connections.

During steel erection by crane, two hand lines should always be attached at each end of the steelwork. Workers controlling the placement of the steelwork using these hand lines should be positioned at a safe distance at least 5 m away from the point of placement.

Points to remember:

- Trying to save crane time by reducing the number of bolts used in connections is a dangerous practice.
- Do not work in high winds or on wet steelwork.

7.2.4 Means of access to working areas

Because of the mistaken belief that steel erectors are in a special class, able to rely on their skill to take care of themselves in all situations, dangerous practices such as climbing bare steel, beam walking (feet on top

flange) and straddling (feet on lower flanges) are commonplace. In general, there are no technical or practical difficulties to prevent the provision and use of working platforms, stagings and working positions for the use of erectors working on the structural framework. In the majority of cases work can be planned and platforms designed to be attached at ground level, raised with the components and removed by crane after use. Often there is no reason why ladders fixed to stanchions before erection should not be used for vertical access. If they are attached to lugs fixed to the steelwork you need not be at risk when the ladders are removed, e.g. by being lifted out by crane after slings have been attached.

Project planning should always include the earliest possible provision of horizontal access between points of structural frames by means of permanent staircases and walkways complete with guard-rails. Prior to this, long-span metal or timber stagings should be used to provide temporary gangways. Where work is proceeding above 6 m, or two storeys high, then a tightly planked temporary floor should be installed. Mobile scaffold towers and mobile hydraulic extending platforms can often be used with greatly improved safety (figure 27), particularly if the site is cleared, access routes are provided and ground floor slabs and temporary floors are laid as soon as practicable.

If sufficient anchorage points are provided and used correctly, safety nets, safety belts and harnesses can save lives or prevent serious injury from falls, and their overall advantages outweigh any possible inconveniences (figure 28). A harness should be used in preference to a belt. A safety net should always be installed when the potential fall is more than two storeys (figure 29).

Steel erection involves a good deal of manual handling and lifting activities resulting in many back injuries and the trapping of hands or feet. You require proper training in safe methods of handling and

lifting, and you should always wear suitable personal protective equipment.

Figure 27. Mobile hydraulic platforms provide safe means of access for steel erectors

Point to remember:

- If you climb or walk on bare steel, sooner or later you will fall.

Discussion

- Why is the incidence of accidents in steel erection so high?
- Describe what can be done to improve safety before steel erection begins.
- What are the principal ways of preventing accidents in steel erection?
- How can you overcome problems of providing safe access and safe working areas?
- What personal protective equipment should be used during steel erection?

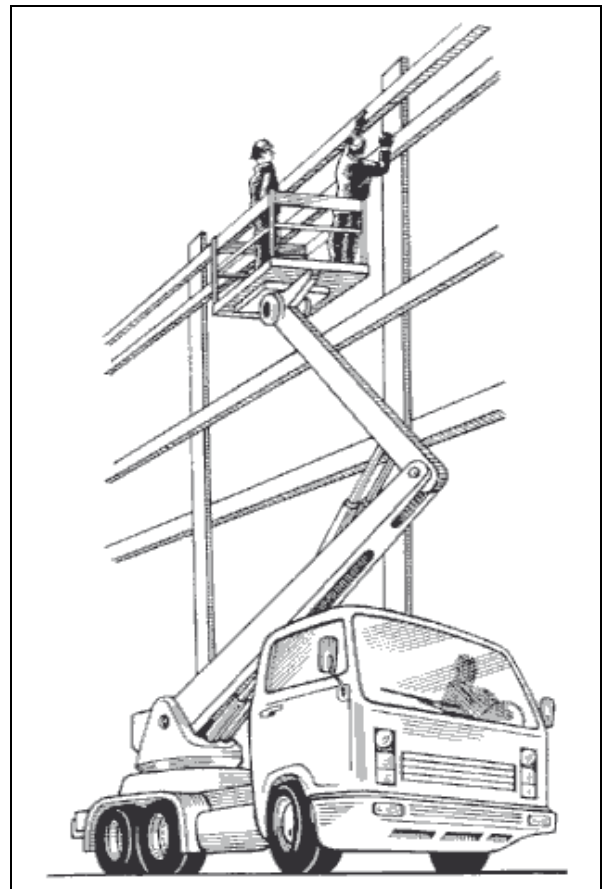
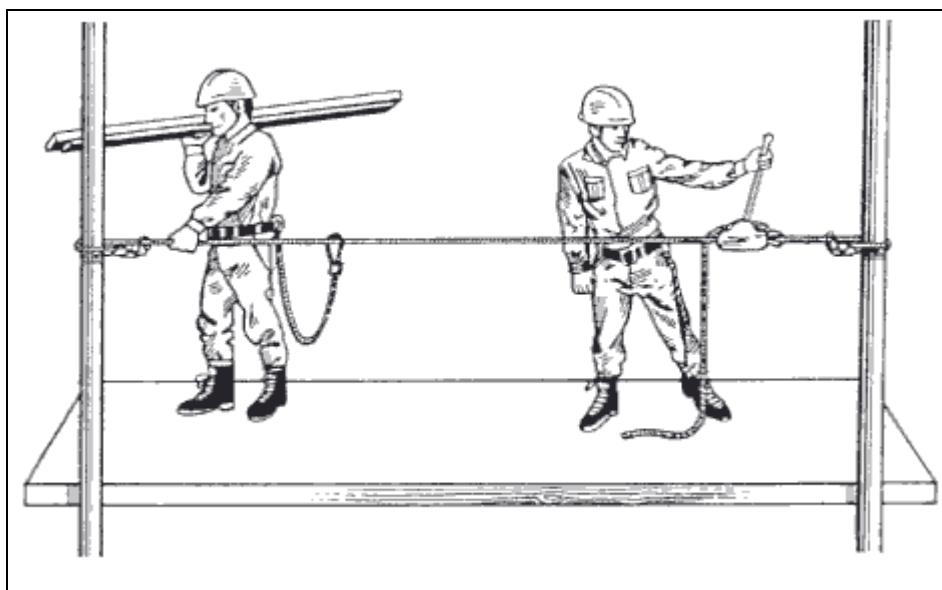
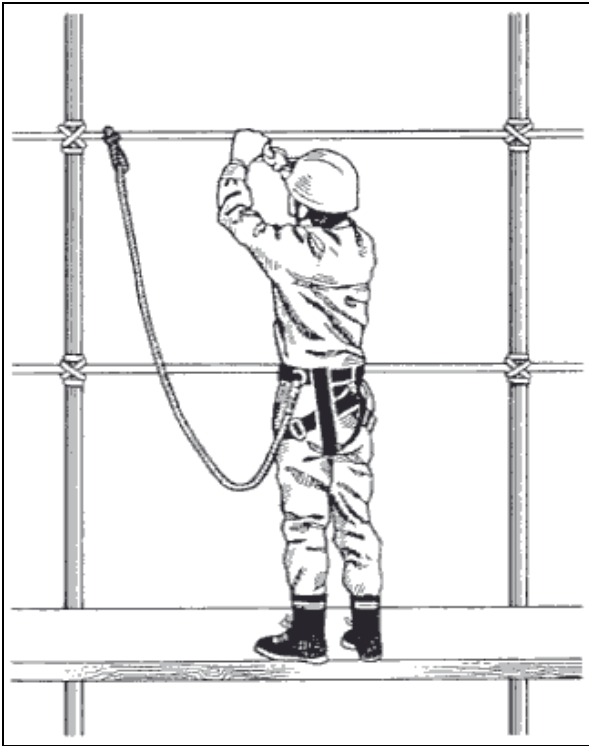

Figure 28. Use of safety belts and harnesses – different ways of providing safe anchorage points for safety lines





- Make sure that the working platform is secure and has no tripping hazards such as tools, wire, timber or bricks. Surfaces soon become slippery and should be treated immediately by cleaning, gritting or applying industrial salt or sand.
- Check that access ladders, guard-rails and toe boards are firmly fixed in position.
- Wear a safety helmet at all times – if you are struck on the head and fall into water you are at special risk.
- Wear a life-jacket, and ensure that it is properly fastened.
- Use any safety nets or safety harness provided.
- Check that lifebuoys fitted with lifelines are ready to hand for immediate use.
- Make sure that there is a safety boat and that it is manned while you are working above water – if over tidal water or a fast-flowing river, it must have a motor with a self-starting device.
- Ensure that you know the routine for raising the alarm and for rescue drill.

7.3 Work over water

Falling into water and being drowned or carried away by currents is an ever-present danger when working over or adjacent to water. Even though you may be a good swimmer, the following precautions should always be followed:

Figure 29. Safety nets to prevent falls of steel erectors

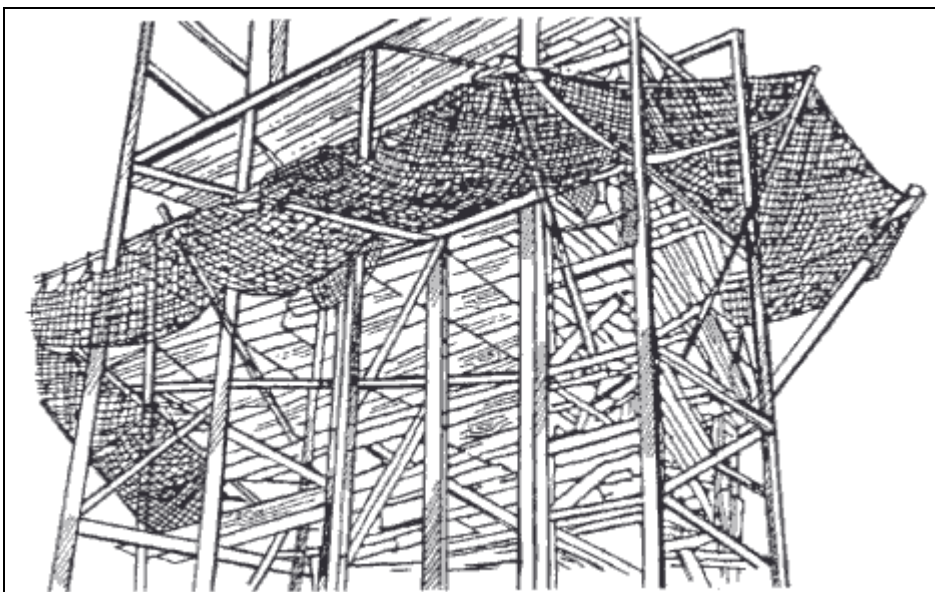

Points to remember:

- Do not work alone when you are working over water.
- Check the number of work regularly to ensure that no one is missing.

Discussion

- What action would you take if a fellow worker fell into deep or swiftly running water?

7.4 Demolition

The principal causes of accidents during demolition are:

- the choice of an incorrect method of demolition;
- an unsafe place of work;
- the unintentional collapse of the building being demolished, or of an adjoining structure, because of lack of temporary support.

7.4.1 Planning and training

The safe demolition of a building depends largely on your knowledge and experience as the supervisor and on your skill as the demolition worker. However, there are vital steps which must be taken by management before you arrive on site.

Demolition must be supervised by persons with a thorough knowledge not only of demolition processes but of the principles of building construction. First, a survey of the physical characteristics and design of the building to be demolished must be carried out in order to choose a safe method of work. Contained within the structure of buildings are various forces and stresses, whether the buildings be of concrete, brick, masonry, steel or timber. When the building is complete, these forces and reactions are in balance, and

equilibrium and stability is achieved. The severance or removal of a load-carrying member may unbalance the forces, upset the equilibrium and cause collapse of the whole or that part of the building. There are particular problems in some newer buildings which are post-tensioned or unbonded stressed structures, or are structures which have been progressively stressed as construction proceeds. Preliminary inquiries of the client or local authority may reveal such problems. The proposals for demolition should be contained in a written method statement which should also include drawings or sketches showing the sequence of operations, and the machinery or equipment to be used, including personal protective equipment.

Demolition is an inherently dangerous process and you and everyone on site must wear personal protective equipment (PPE) including helmet, gloves and safety footwear (see Chapter 12). The presence of debris and dust, and such jobs as the cutting of bolts or rivets, call for the provision of eye protection such as goggles or visors. The use of PPE is an essential part of your training in the basic principles and methods of safe demolition.

Before demolition begins, all services to the building or structure must be disconnected. Failure to do this adequately can result in electric shock, gasing, fire, explosions or flooding. Arrangements should be made to keep the public as far away as possible from the site, and wherever practicable a fence not less than 2 m high should be erected around it.

Points to remember:

- Plan before you demolish and demolish according to plan.
- Have a written method statement for your demolition site.

7.4.2 The demolition process

The aim should be to adopt methods which do not expose you to falls from heights. While in general it is a sound rule gradually to reduce the height of a building and to demolish in the reverse order to construction, a deliberately engineered collapse, the licensed use of explosives, a demolition ball on a crane, or a pusher arm may sometimes be the quickest and most economical method of demolition, leaving work to be completed at ground level. It is dangerous to leave isolated walls or parts of walls standing and liable to collapse from the effect of high winds. Whatever the process adopted, debris should not be allowed to build up against walls or on floors with the consequent risk of the structure being unintentionally overloaded. Make use of debris chutes rather than throwing down

material indiscriminately, even on isolated sites.

Wherever practicable, avoid working directly from parts of the building or structure you are demolishing, such as standing on the top of a brick wall. This usually means that you have both poor handholds and poor footholds.

When work cannot safely be carried out from a building, a scaffold platform, self-supporting and independent of the part of the building being demolished, should be provided (figure 30). On brick and masonry structures in particular, much of the work can be done from such scaffolding, the material being dropped to the interior of the building. Person-carrying skips or power-operated mobile work platforms can also be used to work at heights. The use of safety nets or safety harnesses may sometimes be necessary.

Figure 30. A scaffold platform from which demolition may be carried out safely



7.4.3 Tanks and vessels

The use of hot processes such as flame-cutting to demolish or dismantle plant which has contained flammable materials has caused many deaths and serious injuries. It is essential to make such tanks and vessels safe before work commences, and you should always follow a written permit-to-work system. It is usually easier to ensure that a flammable concentration of vapour is not present in a tank than it is to remove residues. Residue fires during demolition are common. In the case of small vessels up to about 50 cubic metres capacity both vapours and residues can usually be removed by steaming out, but this is often impracticable for larger vessels. The nature and distribution of residues is thus a key factor in deciding on the techniques to be used. Remember that there are other ways of cutting tanks and drums by means of cold processes and these should be considered before you adopt a hot process.

7.4.4 Health hazards

Insidious and unexpected health hazards frequently arise during demolition on account of exposure to dust and fumes. Short-term effects of poisonous fumes, or acute gassing, arise when a plant is opened up without having first been properly isolated, purged or cleaned, or when a vessel is entered without taking precautions. Another cause is the flame-cutting of plant which has been painted with zinc or cadmium paint. Long-term or systemic poisonings arise from flame-cutting lead-painted steelwork, and from the inhalation of dust or fumes from chemical deposits. The site survey should have assessed the risk, and the method of work statement should set out permit-to-work systems, the use of breathing apparatus, approved respirators, and rescue equipment.

Exposure to asbestos-bearing materials is now a particular risk in demolition. Indeed, you may be said to be more at risk from the presence of asbestos than almost any other category of worker. This applies particularly

to exposure to blue asbestos, which was commonly used in sprayed insulation on columns and on the underside of ceilings and roofs for fire protection or for thermal insulation. Stringent precautions need to be taken to avoid contaminating the general atmosphere and to prevent breathing in of the dust. Material containing asbestos must be removed in isolation from other work, and you must wear positive pressure breathing apparatus and protective clothing, and be trained in their use and the techniques of asbestos removal (see Chapter 12). Where possible, wet methods of asbestos removal should be adopted rather than dry methods. Special arrangements need to be made by management for the safe disposal of asbestos-contaminated debris.

Points to remember:

- Never work on a tank or enclosed vessel without a written permit to work.
- Always check whether asbestos is present in the building to be demolished.

Discussion

- What should be done before demolition begins?
- How should demolition proceed?
- What are the common dangers to your safety and what precautions would you take?
- What are the special dangers to your health and what precautions would you take?

7.5 Confined spaces

7.5.1 Hazards

Every year there are fatal and serious accidents caused by persons entering confined spaces without the necessary tests being

carried out or the correct safety and rescue equipment being provided. In many cases attempted rescue has ended in tragedy, with the death of the poorly equipped rescuer as well as the person to be rescued. While a closed tank with a restricted access opening may be the obvious example of a confined space, such spaces may also include open manholes, sewers, trenches, bored piles, pipes, ducts, enclosed basements and other places where there is inadequate ventilation.

Dangerous atmospheres can arise when there is a lack of oxygen or when toxic or flammable gases are present. These may be due to exhaust gases from plant and transport, carbon dioxide forming in chalk soil, decomposition of sludge in a sewer, leaks from gas mains, rusting of metalwork, or the presence of petrol and various kinds of waste from factories and trade premises. Work being done in a confined space can make it dangerous. Examples are some painting work, the use of adhesives to fix floor tiles, and cleaning fluids.

Many of these accidents would have been avoided if supervisors and workers had been properly trained and a permit to enter and a permit to work system had been in operation.

If you are actively engaged in work in confined spaces, you must be fit and properly trained for the job, and have the necessary personal protective equipment. You should remember that an oxygen deficiency can render you unconscious, and that toxic fumes can additionally cause dizziness and a feeling of sickness, while gases can be flammable or explosive.

7.5.2 Safety precautions

The following precautions are essential before you enter a confined space regardless of any work you intend to carry out:

- Never enter without instructions from a supervisor and without a written permit to enter or permit to work.

- Equipment for monitoring the atmosphere at frequent intervals must be provided and must be used by a competent person. You must not enter the confined space until the competent person is satisfied that entry is safe.
- There should be forced ventilation to remove and dilute dangerous gases and provide fresh air.
- Monitoring must continue while work proceeds, and you must leave immediately if told to do so.
- You should have received proper training and instruction in the precautions to be taken, including the use of emergency breathing apparatus.
- Rescue harnesses should be worn by everyone inside the confined space, with lifelines attached to a point outside the space.
- Not less than two persons should be present when there is work in a confined space. One should be outside the confined space to keep watch and to offer rescue action or assistance. Additional emergency and accident assistance must also be readily available.
- A proper procedure for rescue in an emergency should be laid down, with specific duties allocated to specific persons. If you play a part in this procedure, make sure that you clearly understand what you have to do. Even if you think lives are at stake, you must still follow the procedure and must not take short-cuts.
- When working at a manhole in a road or public area, ensure that guard stands are provided and the appropriate traffic signs displayed.
- Make sure that you have been trained by a competent person in the use of the safety and rescue equipment.

Some of these points are illustrated in figure 31.

Figure 31. When entering a confined space, use a lifeline with a second person present and self-contained breathing apparatus

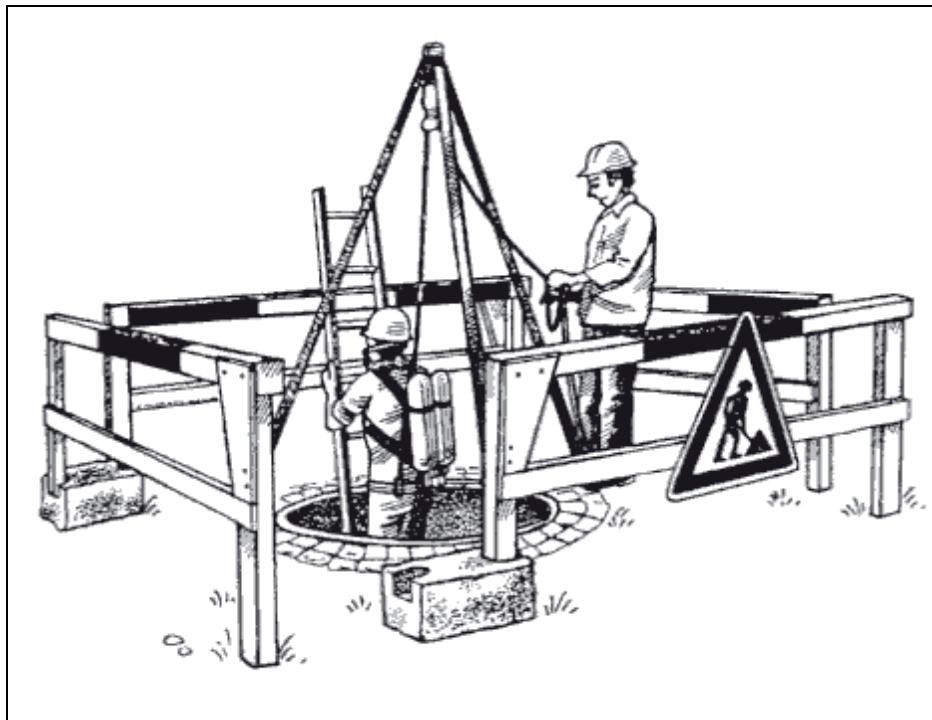

7.5.3 Safety and rescue equipment

Whenever work is to be carried out in a confined space, the following equipment should be provided:

- an atmospheric testing device (proprietary meters and lamps are available);
- two rescue harnesses with adequate lengths of rope taking into account the location of the work site;
- hand torches or lamps safe for use in a flammable atmosphere;
- at least one set of suitable breathing apparatus (cartridge, canister or filter) and an emergency breathing pack;
- first-aid equipment;
- firefighting apparatus;
- an audible alarm for summoning help;
- resuscitation equipment;
- means of communicating with surface workers.

Points to remember:

- Never work alone in a confined space.
- Never rely on your senses to tell you whether an atmosphere is hazardous.
- Never attempt to clear fumes and gases with pure oxygen because of the risk of being enveloped in fire if there is a source of ignition.
- Never rely on cartridge, canister or filter respirators in confined spaces.

Discussion

- On what sort of construction work might you find confined spaces and hazardous atmospheres?
- Have you ever worked in a confined space – What was it and were the above precautions followed?
- A worker collapses in a confined space – What would you do?

7.6 Piling

7.6.1 General precautions

There are certain hazards which are common to all types of piling, and the following precautions are necessary:

- piling machine operators should be over 18 years of age and properly trained;
- prior to piling, all underground services should be located and made safe. A check should be made to ensure there are no cellars, underground water courses or ground conditions which might cause hazards;
- there should be a firm level base for the crane, or crane mats provided;
- when working on piling operations you must wear a safety helmet, and ear and eye protection where necessary;
- all cranes, lifting appliances and lifting gear must have appropriate certificates of testing and thorough examination, and should be large enough for the job;
- particular attention should be paid to the risk of damage to lifting gear from sharp edges;
- cranes used for raising or lowering workers must be fitted with a dead man's handle and lowering should be done under power; you must be carried in properly constructed cages which cannot spin or tip;
- piling contractors should be asked to provide a written method statement setting out the precautions relevant to the type of piling they are to employ;
- induction training and information for you as supervisor or operative should be specifically related to the method statement.

Point to remember:

- Wear your protective equipment at all times when piling.

7.6.2 Bored piles

You may need to enter a borehole for inspection or for clearing out in undercuts, and there are certain precautions which must be taken prior to your entry:

- the borehole should be at least 75 cm in diameter;
- the borehole should be treated as a confined space and the precautions which are advised elsewhere to ensure a satisfactory atmosphere must be closely followed;
- waste material from the borehole should be kept clear of the borehole;
- descent into a borehole should be in properly designed skips, chains or cages fitted with an anti-spin device. The power source of the lifting appliance should be kept running throughout the time someone is underground;
- while you are working down a borehole you must wear a safety harness;
- all workers concerned must be trained and competent in rescue from deep boreholes, and emergency rescue drills should be carried out at regular intervals;
- a banksman who can see you in the borehole should be present at all times;
- there must be adequate lighting at safe reduced voltage and a means of communication from the borehole.

Wherever possible, the need for workers to enter pile boreholes should be avoided by the use of television cameras and other techniques for remote inspection.

Discussion

- What are the dangers of piling and what should be done to overcome them?

8. Vehicles

8.1 Causes of accidents

The underlying cause of most site traffic accidents is the failure to plan a safe system of work and to train workers how to follow it. However, the common immediate causes are one or a combination of the following factors:

- bad driving techniques which include reversing blind;
- carelessness or ignorance of special hazards, e.g. work near overhead power lines or excavations;
- carrying unauthorized passengers;
- poor maintenance of vehicles;
- overloading or bad loading;
- site congestion;
- poor traffic layout;
- lack of proper roadways combined with uneven ground and debris.

8.2 Safety precautions

Transport may include trucks, tipper lorries, tractors and trailers, and small dumpers. As a driver you must be properly trained and if you take a vehicle on or across a public road you usually need to possess a national driving licence. It is good practice for all drivers to possess a driving licence in any case. Training should include instruction on negotiating steep slopes so that you know, for example, that you should drive a vehicle up and down the slope rather than across it, whenever practicable.

Routes should be levelled, marked and planned in such a way as to avoid potential hazards such as overhead power lines and steeply sloping ground. Where possible a one-way system should be used. Speed limits should be required and clearly displayed, they should be reduced for adverse site conditions and for areas near work in progress.

If routes have to approach overhead structures or overhead power lines, contact with them can be avoided by erecting warning barriers of the goalpost type (figure 32). The crossbar should be of rigid material, preferably timber, and painted in two contrasting warning colours. In the case of power lines, there should be a barrier on both sides of the line and set at least 6 m horizontal distance away. If you are operating a crane in the area of overhead power lines, make sure that arrangements have been made in advance with the power company for power to be diverted or cut off whenever the crane is in use.

Workers are frequently struck by vehicles travelling backwards when the driver's rear view is obscured. Enlist the help of another worker before you reverse and keep him or her in view at all times. If no one is available, walk round to the rear of the vehicle yourself to see that all is clear and give a sound signal before starting to reverse. Many vehicles now have an audible warning device such as a horn or warning hooter which sounds when reverse gear is engaged, but as a driver you should not rely on this alone.

An unattended vehicle should have the engine switched off, and unless the vehicle is on a marked incline the gear should be left in neutral and the handbrake on, on sloping ground the wheels should also be chocked. Tipping bodies should be lowered when the machine is unattended, but if it is occasionally necessary to leave them in the raised position they should be blocked to prevent their fall.

Foot injuries to drivers and their assistants during loading and unloading are common, and you should wear safety boots or shoes.

Maintenance of vehicles falls into three categories:

- a daily check by the driver of water, oil, fuel, lights, inflation of tyres and brakes – remember the acronym WOFLIB;
- a weekly check by a fitter;
- periodic servicing to the manufacturers' requirements.

A written record of maintenance and repairs should be kept on site.

Points to remember:

- Keep your vehicle tidy and the cab free from tools and material which might obstruct the controls.
- Keep to speed limits.
- Do not carry unauthorized passengers.
- Do not drive across a slope.

Figure 32. Goalposts to compel drivers to lower crane and excavator jibs, and avoid contact with overhead power lines

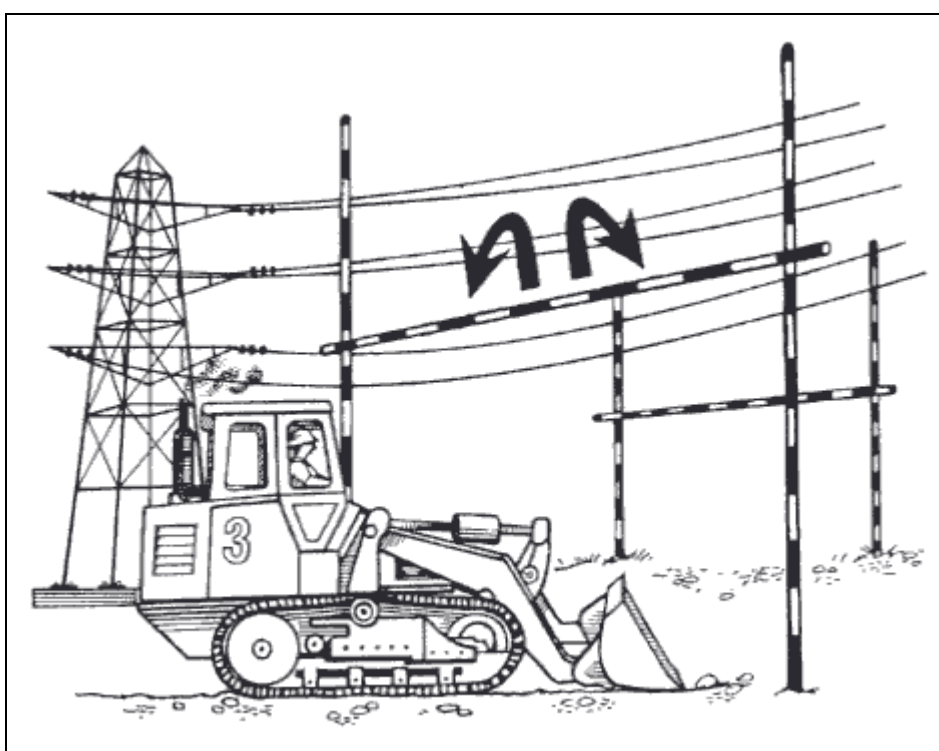

8.3 Overturning

Falls of vehicles into excavations or openings occur frequently when vehicles get too near the edge of an excavation and cause the side to cave in, or when in tipping materials over the edge the driver approaches too close and cannot stop in time. The precautions are barriers, banksmen and fixed stops, as discussed in Chapter 4. Construction vehicles are often basically unstable and liable to overturn, and it is therefore important not to turn at an excessive speed. Vehicles such as tractors and lift trucks should be equipped with

protection to prevent the driver being hit by falling objects and from being thrown from the cab in the event of overturning.

Point to remember:

- If your vehicle begins to topple over, remain in the seat and do not try to jump clear.

8.4 Loading

Loads within the capacity of the vehicle should be evenly distributed and properly secured, and should not project beyond the plan area of the vehicle. If some degree of projection is unavoidable, it should be clearly shown by the attachment of flags. Uneven loading can cause a loss of control when cornering or braking, and insecure loads may swerve or fall off the vehicle during travel. The body of a tipper lorry should always be lowered before you drive off.

Loading and unloading should be an integral part of driver training.

Points to remember:

- Use the steps if fitted, otherwise use the wheel rims to dismount from the cab; do not jump.
- Never mount, or dismount from, a moving vehicle.

Discussion

- What are the principal reasons for site vehicle accidents?
- What further precautions to those mentioned can you take to prevent site vehicle accidents?

9. Movement of materials

9.1 Cranes

Before a crane is used on site, management should consider all the factors that could affect its safe use, such as:

- the weight, size and type of load it will have to lift;
- the maximum reach or radius required of it; restrictions on use such as overhead power lines, the state of the site and the type of ground;
- the need for trained operators and signallers.

9.1.1 Erection

Both the erection and dismantling of cranes should be done by skilled workers under the immediate direction of a competent and experienced supervisor. The manufacturers' instructions should be closely followed.

9.1.2 Signalling

Crane operators and signallers must be over the age of 18, and trained and sufficiently experienced. There should always be a signaller, or a signalling system such as a telephone, if the crane operator cannot see the load throughout the lift. Hand signals should be clear and distinct, and should follow a recognized code or system (figure 33).

9.1.3 Overloading

Overloading, causing vital parts to be stressed beyond rated capacities, can easily occur when neither the operator nor the supervisor is able to estimate the weight of material to be lifted, which is likely in the case of odd-shaped items. An operator who is not properly trained may then lower a load at too high a speed so that when the brake is abruptly applied the jib snaps. All cranes should be marked with their safe working load which

must not be exceeded during the use of the crane. In the case of cranes with a derricking jib, that is with a variable operating radius, the safe working load should be shown for every radius of the jib. Winches and pulley blocks should be similarly marked.

Figure 33. Hand signals to crane drivers should be clear and distinct, and should follow a recognized code or system

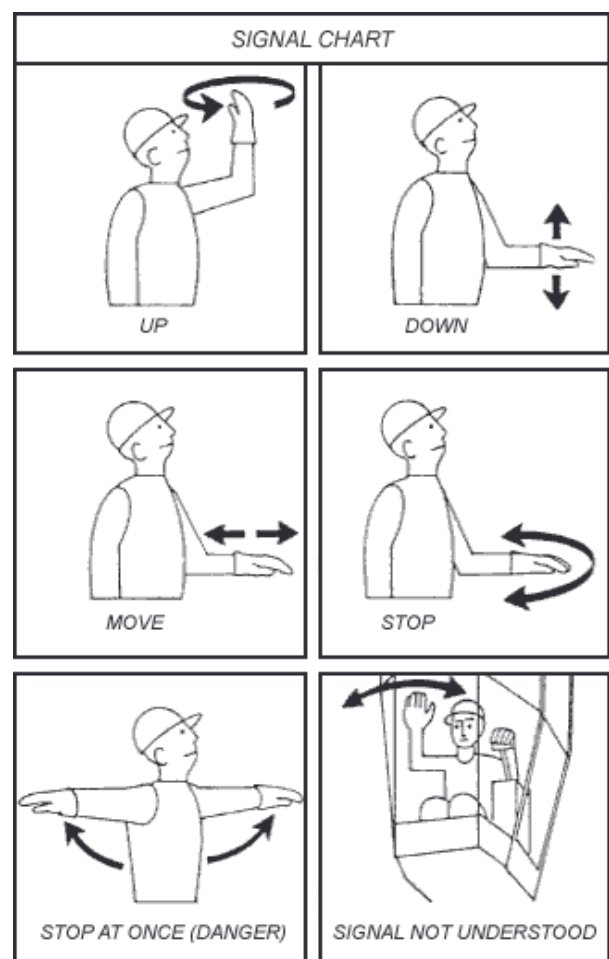

9.1.4 Safe load indicators

All jib cranes should have an automatic safe load indicator which alerts the operator, usually by a light, just before the safe load is reached, and warns both the operator and others nearby, usually by a bell or hooter, if the safe load is exceeded. The safe load

indicator is an aid to safe crane operation, but does not guarantee it. For example, it does not take into account the effect of wind or soft ground conditions. If you are lifting a load that you know or believe to be close to the safe working load, do not proceed immediately to a full lift. Rather raise the load a short distance and stop to check the stability of the crane before continuing with the lift. Remember that if a load is allowed to swing or is lowered rapidly, the radius of the jib may be increased unintentionally by flexing of the jib. Some indicators operate also as an overload cut-out. Never bypass the indicator in order to lift an overload.

Points to remember:

- If you cannot see the load all the time, you need a signaller.
- Beware of exceeding the safe working load when trying to free a stuck load.

9.1.5 Inspection and maintenance

Cranes are subject to wear and tear which may not be easily detected: for example, bolts and similar parts may be subject to metal fatigue. Cranes should be tested and examined by a competent person before they are used on a construction site, and subsequently inspected at regular intervals in accordance with government requirements. The manufacturer's recommended programmes of operator checks and maintenance should be followed and any damage or defect should be reported to the supervisor. Never use a crane if you think it unsafe.

Particularly susceptible components are wire ropes, brakes and safety devices. The constant contact of wire ropes with the sheaves on the jib accelerates wear. Brakes are in constant use and need to be checked, adjusted or renewed regularly. Safe load indicators and other safety devices such as overload cut-outs and limit switches are often susceptible to

breakdown under site conditions and are sometimes deliberately disconnected.

9.1.6 Mobile cranes

A mobile crane is inherently unstable and is liable to overturn if used on uncompacted ground or on a slope. Remember that rain can soften the ground and sites which are not level impose strains on the crane which may lead to unintentional overloading.

From your training as a crane operator you should understand the advantages and limitations of outrigger settings (figure 34), and be aware of the dangers of failing to use them. Lifting outdoors may be made more difficult or hazardous by the wind. Make sure that there is adequate clearance for the crane's jib or boom and counterweight from traffic and fixed structures such as buildings, and that no part of the crane or the crane load will be closer than 4 m to live overhead power lines.

Figure 34. Mobile cranes should operate with outriggers extended to prevent overturning

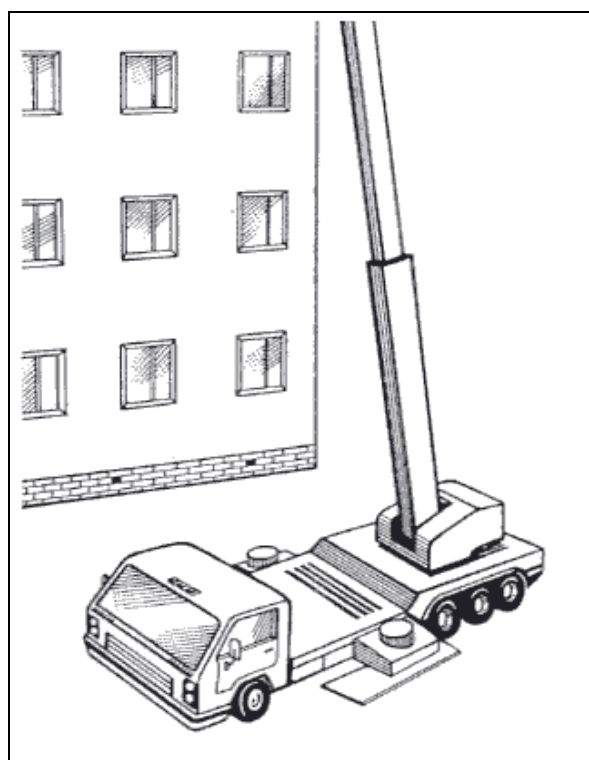

All cranes should be fitted with a safety hook designed to prevent accidental dislodgement of the load if it fouls something or meets an obstruction during the lift (figure 35).

Points to remember:

- Is there a safety hook fitted?
- Is there adequate clearance for the crane's jig or boom?
- Make sure there are no drainpipes beneath the outrigger pads.

Figure 35. Cranes: The need for a safety hook fitted with a latch to prevent displacement of loads is explained to workers

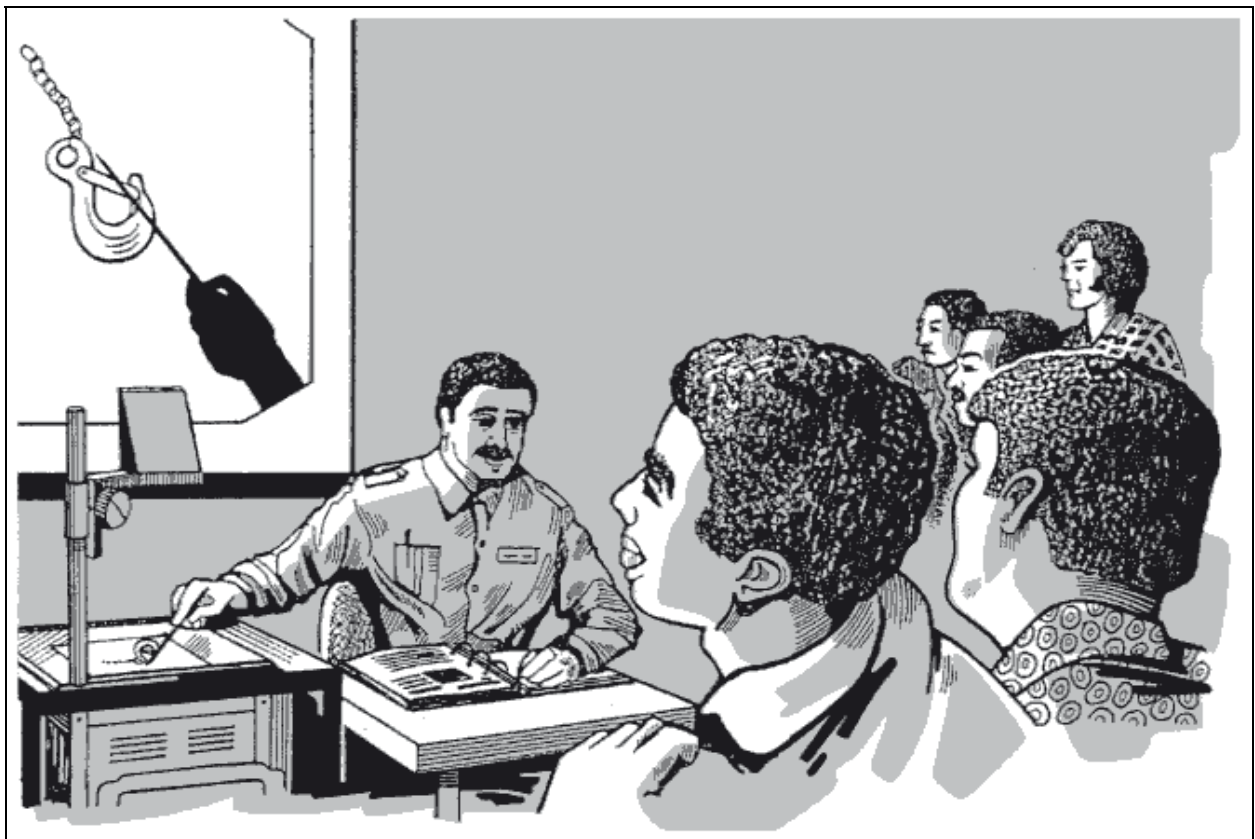

9.1.7 Tower cranes

To prevent overturning, a tower crane must either be anchored to the ground or securely counterweighted or ballasted. If the crane is rail mounted, remember that the rail tracks cannot be used as an anchor. Because ballast material may be moved, a diagram of the counterweight or ballast should be fixed to the crane, and the ballast should be checked against this whenever the crane is erected, and after bad weather.

Make sure that equipment such as slings and chains used with the crane does not clutter accessways or ladders and is well clear of any machinery in which it may become entangled.

Loads must be lifted vertically, as any out-of-vertical lifting may result in crane collapse. Never lift loads having a large surface area in windy conditions.

The crane must be positioned to ensure that the crane jib or boom is free to windvane

or turn through 360° around the tower. Crane manufacturers specify the maximum wind speed at which tower cranes may be safely used.

Point to remember:

- Never climb up the tower or get onto the boom while the crane is in use.

9.1.8 Cranes used in demolition

A cast-steel ball or weight suspended from a crane jib is an extensively used method of demolition. Cranes as such are not designed for extremes of shock loading likely to arise when a demolition ball is in use and therefore should be used only to drop the ball vertically on a free fall for such operations as breaking up concrete slabs. They should not be used for swinging the ball. Excavators which are convertible to cranes are designed for drag-line operations which impose a shock load and are more suited to use with a ball. The excavator manufacturer's recommendations as to weight and attachment of the ball should be followed. Generally the weight of the demolition ball should not be more than 33 per cent of the machine's safe working load and not exceed 10 per cent of the hoist rope's minimum breaking load. All parts should be inspected twice daily, and a high standard of maintenance is necessary. As an operator you need to be familiar with demolition balling and should be protected from debris by a protective structure with safety glass or metal mesh.

9.1.9 Lifting appliances used as cranes

Machines such as excavators, back-hoe diggers and front-end loaders are used as cranes when they handle loads suspended by slings.

The precautions previously advised for mobile cranes apply in general, although a safe load indicator and a radius indicator are not

generally fitted if the load lifted is kept below 1 tonne. Whatever the load, you should ensure that the machine can safely lift and place it exactly where needed.

9.1.10 Slings and ropes

Only slings and ropes which have a marked safe working load should be used. Pad sharp corners of the load to prevent damage to the sling and make sure you have screwed home the shackle pins.

Point to remember:

- Make sure the load you are lifting is properly secured.

Discussion

- How would you describe a crane?
- What site conditions make it unsafe to use a crane?
- What are the safety devices used on cranes?
- What types of lifting machinery are subject to inspection and testing?
- What should inspection and testing consist of and how often should they be done?

9.2 Goods hoists

The goods, or platform, hoist used to raise materials and equipment vertically to successive levels as construction proceeds is probably the most widely used item of mechanical handling equipment. It consists of a platform which is driven either from a rope winch or by a rack and pinion with the motor and gearbox mounted on the platform. The principal dangers are of falling down the hoistway from a landing on the platform, being struck by the platform or other moving parts, and being hit by materials falling down the hoistway.

9.2.1 Erection

The erection, extension and dismantling of hoists is a specialized job and you should carry it out only under the charge of a competent supervisor. The tower or mast of the static hoist needs to be securely tied to a building or scaffold and maintained vertical, so that no undue stress is imposed on the tower, with consequent misalignment and interference with the platform. Mobile hoists should be used only to a maximum height of 18 m unless a greater height is specified by the manufacturer.

9.2.2 Enclosure

A substantial enclosure should be erected at ground level around the hoistway to a height of at least 2 m. It should have suitable gates giving access to the platform (figure 36). The remainder of the hoistway should be enclosed (e.g. with wire mesh) throughout its height sufficiently to contain falling material within the enclosure. Gates should be fitted at every landing level where access to the platform is needed, and you must keep the gates closed except when you are actually loading and unloading at that level.

9.2.3 Safety devices

An overrun device should be fitted just above the highest platform position required, or near the top of the mast. An arrestor device should be fitted to support the platform, fully loaded, in the event of failure of the hoist rope or driving gear. There should be at least three turns of rope on the winch-drum when the platform is in its lowest position.

9.2.4 Operation

To prevent the hoist operator, who should be trained and aged at least 18, from moving the platform while someone is trying to load or unload materials, the controls need to be set up so that the hoist can be operated from one position only. Make sure that from this position the operator can see all landing

levels clearly. If this is not possible, a signalling system must be used during loading and unloading. There should be overhead protection for the operator if, as is usually the case, he or she is at ground level.

9.2.5 Loads

The platform should be clearly marked with its safe working load and the platform should not be overloaded. Barrows should not be overfilled, and their wheels should be chocked or secured so that they cannot move about on the hoist platform while it is moving. Loose bricks or other materials should never be carried on an open hoist platform. No one should be allowed to ride on the platform and there should be a notice on the platform forbidding riding.

9.2.6 Carriage of persons

Lifts for the carriage of persons need to be especially constructed and installed for the purpose, with such features as mechanical and electrical interlocking devices on the cage and landing gates.

9.2.7 Testing and examination

Every hoist should be tested and examined after installation, and checks made on the arrester and overrun devices. Weekly recorded checks should then be made by a competent person.

Points to remember:

- Place barrow handles facing the direction of the offloading exit, when loading the platform on the ground.
- Never ride on the platform of a goods hoist.
- Keep the landing gates closed whenever you are not loading or unloading.
- Make sure the platform is stopped at the landing level before you step onto it.

Figure 36. Goods hoist with enclosure and gates to prevent workers being struck by the platform

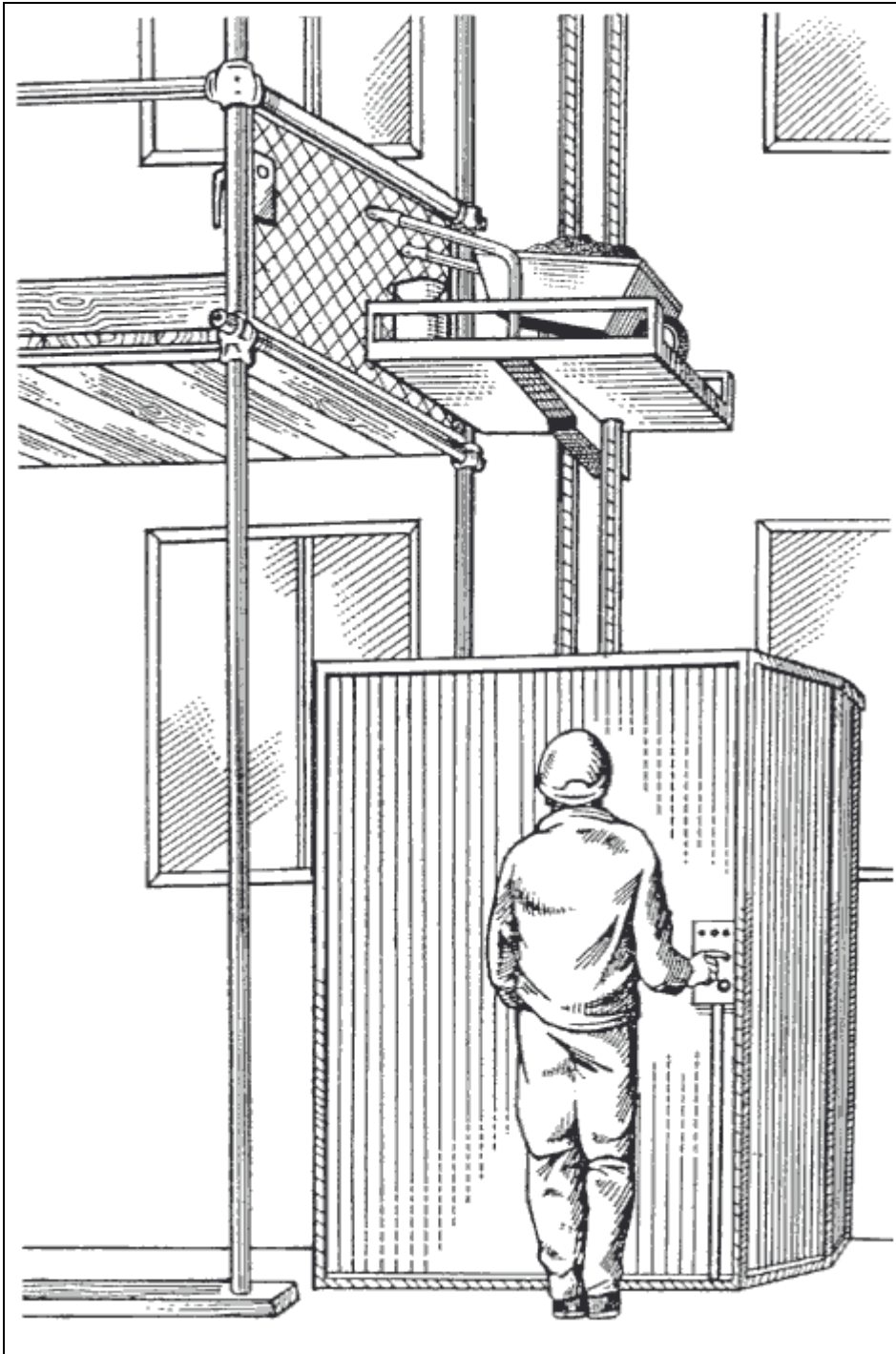

9.3 Gin or pulley wheels

9.3.1 Causes of accidents

Gin or pulley wheels are a common and inexpensive way of lifting small loads a

limited distance. The most common accidents occur when:

- the pole on which the wheel is mounted relies on a single support – two supports are always required (figure 37);

- the hoisting rope is not fitted with a properly made safety hook – hooks made of bent reinforcing rod are dangerous;
- the hoisting rope is worn, chafed and no longer serviceable;
- the bucket or load strikes the scaffold or building, tipping out its contents;
- the load is too heavy or is not secured;
- an appliance mounted on a roof does not have a secure anchorage to prevent overturning – there should be a safety factor of at least 3.

- if the height of the pulley is over 5 m, a ratchet and pawl mechanism should be considered;
- where the pulley is mounted near the edge of a roof or floor, guard-rails and toe boards are required;
- if two or more of you are lifting, one should give instructions to ensure that the team works together.

Point to remember:

- Make sure that the load you are lifting is properly secured.

Figure 37. A gin wheel should always be secured to at least two supports

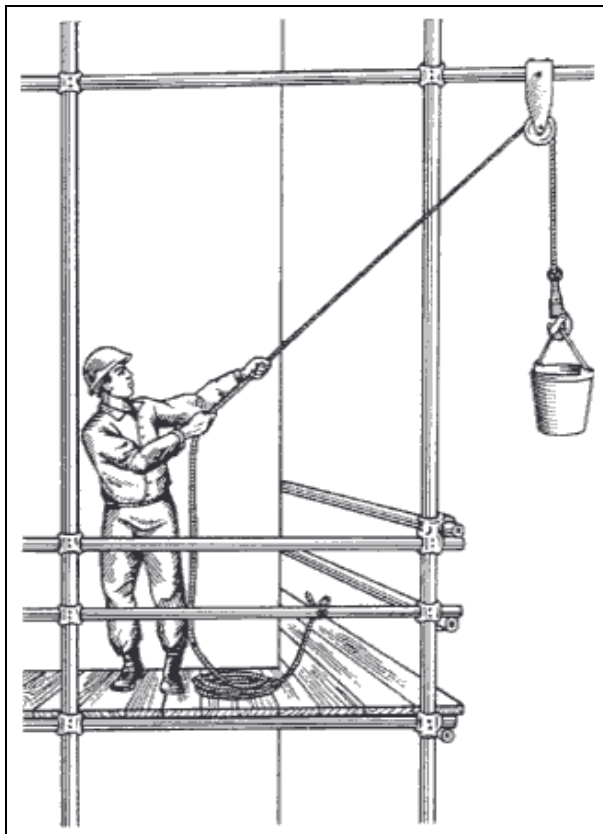

9.3.2 Safety measures

The following precautions should be taken:

- if liquid is transported in a bucket, there should always be a cover;
- when you are hoisting the bucket, always use gloves to protect your hands;

9.4 Manual handling

The handling of raw materials and building components is an integral part of the construction process. Manual handling of loads and materials is still very common. Many workers carry out heavy lifting and carrying operations during much of the working day. Next to falls, manual handling is the most common cause of construction accidents.

The proper mechanical handling of materials can ensure that work flows smoothly, and helps to avoid delays and damage. In manual materials handling too, one can apply techniques and ideas which increase efficiency and are not expensive. These “low-cost” solutions most frequently arise from local needs and experience.

When approaching the problem of safe manual handling of materials there are three important questions you should ask:

- Can mechanical equipment be used in place of manual handling?
- Can the load be lightened or suitably shaped for manual handling?
- Have you been trained in proper methods of lifting and carrying?

9.4.1 Lifting and carrying

Almost one-quarter of work injuries occur during manual handling, most of which are strains to the hands, legs, feet and back. Much construction work involves heavy manual labour and workers not in good physical condition tire easily and are more susceptible to injury. You should know your physical capabilities and only tackle jobs you can reasonably handle. It is important, too, to have been trained in the right techniques of lifting and carrying. Look after your own welfare by:

- putting the load on wheels if you can instead of carrying it;
- using mechanical handling equipment if you have been trained to use it;
- wearing the right equipment for the job such as safety boots,
- checking the weight of the load before lifting;
- not lifting loads higher than is necessary;
- checking that there are no overhead power lines or obstructions when you are carrying a long load such as scaffold tubes or reinforcing rods;
- removing or securing loose objects on the load;
- getting assistance if the load is too heavy or awkward for you to handle on your own;
- making sure that there is a clear walkway to your destination and a safe stacking place.

9.4.2 Lifting technique

The size, shape and structure of the material will largely determine how easy or difficult manual handling will be. Well-designed and well-placed handles are of great help. Whenever you lift a load, follow the following procedure:

- Stand close to the load on a firm footing and with feet about 30 cm apart.
- Bend the knees and keep your back as straight as you can.
- Take a firm grip on the load.

- Breathe in and throw the shoulders backwards.
- Straighten the legs, continuing to keep the back as straight as you can.
- Make sure that your view is not obstructed by the load.
- Keep the load close to the body.
- Lift slowly and smoothly.
- When carrying a load, avoid twisting the spine to turn; move your feet instead.
- If two or more of you are lifting, one should give instructions to ensure that the team works together.

Figure 38 shows the right and wrong ways to lift a load.

Point to remember:

- Correct lifting and carrying calls for training and practice.

Discussion

- What steps can be taken on your site to improve materials handling?
- Have you had training in the correct method of lifting and carrying?
- What handling aids do you have on your site?

Figure 38. Right and wrong ways to lift a load

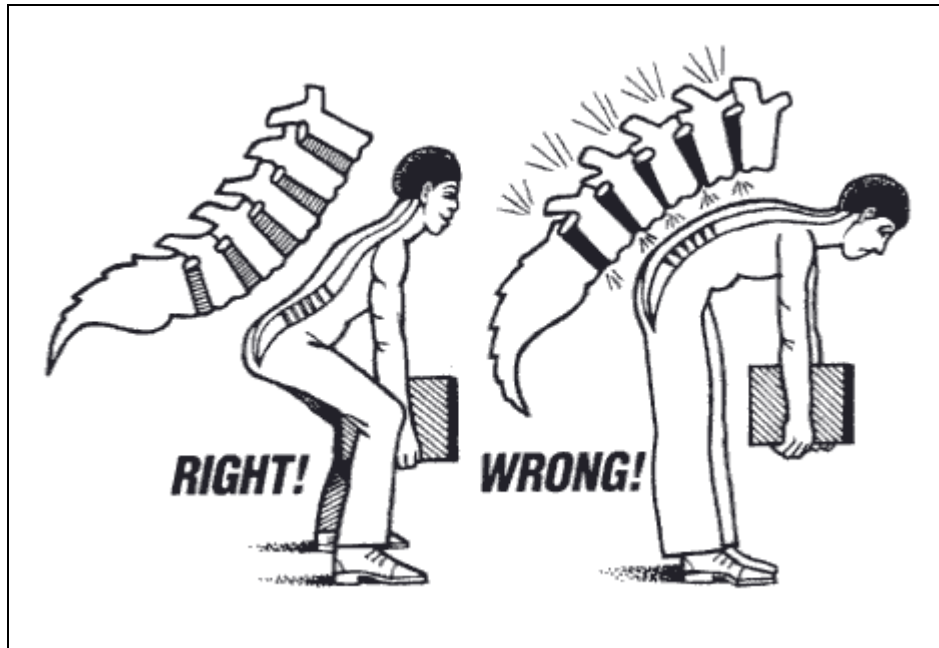

10. Working positions, tools and equipment

10.1 Fitting work to people: Ergonomics

The technical development of the construction industry has led to reliance on machines and technical equipment for much heavy work previously done by hand. Although there are still many tasks on site which are carried out using manual labour, it is difficult to envisage high-rise building construction without cranes, excavators, concrete mixers or pile drivers. Mechanization has, however, brought new problems to the workplace.

Technology changes faster than people and technological change often exceeds people's ability to adapt. As a construction worker, you know the difference between a tool that is well suited for you and for the job, and one that is not. You also soon become aware of the difference between a comfortable working posture and one that is uncomfortable. Ergonomics or human engineering is a multidisciplinary way of looking at the interrelationship between the worker, the workstation and the working environment. Ergonomics plays a key role in the humanization of work, in increasing productivity, and in improving safety and health.

Even with new and modern technologies a lot of heavy work is still done by hand. Tools, machines and equipment are in many cases old-fashioned, poorly designed or badly maintained. Many operatives on construction sites are unskilled. Heavy loads frequently have to be carried up and down stairs, ladders and scaffolds, and people working on construction sites often suffer from low back pain or injury to muscles and joints.

The construction industry has a wide range of jobs and processes. These change

according to the stage of the project. They involve consideration of:

- working positions, both standing and sitting;
- work which is especially strenuous;
- the use of hand tools and equipment.

Discussion

- How have various machines changed work methods in the construction industry in the past few years?
- What are the positive and negative effects of tower cranes and excavators on your work?

10.1.1 Strenuous and heavy physical work

Continuous heavy manual work increases the rate of breathing and the heart. If you are not in good physical shape, you will tire easily. There are risks involved in working at maximum physical capacity. The use of mechanical power to replace heavy work helps reduce these risks. Mechanical power also helps increase the work opportunities for people with less muscle power. On the other hand, jobs that require no physical effort are often mentally tiring and boring. It is important that the workload is not too heavy and changes during the day. Effective rest periods should always be included in the day's work.

Discussion

- Is work affected by differences in workers' heights and weights?
- Are there any jobs on your site that workers try to avoid?
- Name some jobs which are strenuous. Are there any alternative methods to carry out the task with less strain?

10.1.2 Static loads

The most natural way to work is rhythmically. When sawing with a handsaw, the hand holding the saw is doing dynamic work and the other hand static work. This “dynamic” load enables the muscles to alternate between contraction and relaxation. If an object is lifted up and held in this position, this puts the muscles under a uniform “static” load. Muscles under static load become tired because they are continually contracted, and after a short time the muscles feel painful. A static load on the muscles over a long period will also increase pressure on the heart. The pulse increases because the blood remains in the muscles.

On building sites there are many jobs where the worker is exposed to heavy static loading. Finishing work on walls and ceilings, painting and electrical wiring work frequently require you to work with arms above your shoulder line, and frequent changes of posture are desirable.

10.1.3 Working postures

On construction sites people work in a variety of different positions. Some workers are climbing up scaffolds, others are using hammers while on their knees, while others are working on surfaces above their heads. Until recently, little attention has been paid to good working positions. It is frequently argued that construction work unavoidably requires many different and changing postures, but it is clear that the principles developed for good working positions in industry apply also to construction.

Difficult working positions lead to spending longer over tasks and lead to fatigue. For example, working with one’s arms raised rapidly tires the shoulder muscles and work requiring bending or twisting can easily cause back strain (figure 39). A poor working posture translates into a gradual increase in operation time and an increased possibility of injury or damage to material or equipment.

Figure 39. Where possible, workers should not work on surfaces above their heads, as this increases the strain on arms, back and neck



10.1.4 Sitting and standing positions

Posture is defined by the working method applied and by the tool in use. When considering posture, you have to take into account the reach and muscular power of the worker involved. Where possible, work should be done in a sitting position. However, a standing position is often unavoidable in construction work where high muscular power, greater reach or considerable movement is involved.

A well-designed workstation provides possibilities for the worker to carry out the operation in many positions and postures, both sitting and standing. It also allows the worker to walk a little during the working day.

Although there are very few fixed sites in the construction industry, there are many operations where difficult postures can be improved by simple, low-cost measures. For example, welders often have awkward working postures and a simple, light three-legged stool or chair is useful.

Points to remember:

- Arrange to sit whenever possible.
- Keep materials, tools and controls within easy reach.
- Make sure you got close enough to the task.

Discussion

- Describe several different working postures you have seen on your site and how they could be improved.
- Hold your hands out straight for a while. How do you feel?
- Bend your body forwards and hold that position. How do you feel?

10.1.5 Work in cabins

Machines with cabins for the operator are frequently used on construction sites. Examples include excavators, tower cranes, bulldozers and trucks. In recent years manufacturers of these machines have paid a great deal of attention to the working conditions of the operator. Regular checking and maintenance are needed if these conditions are to remain intact over the working life of the machine. Here are some key points to check:

- Is there easy access to the cabin?
- Are controls in good working order and within easy reach?
- Is the construction of the cabin solid, are windows and noise insulation in place, and are lights working?
- Is the operator's seat in good condition, adjustable and securely anchored?
- Is the instrumentation functioning?
- Is the engine exhaust pipe placed away from the cabin and in good condition?
- Are the engine covers and enclosures in place?

10.2 Hand tools

There are many different types of hand tool for different kinds of work, such as shovels, axes, crowbars, chisels, screwdrivers, hammers and wrenches. In many instances these tools are bought from an outside vendor without paying any attention to their design or quality.

A good-quality hand tool should be designed to fit the hand and the task. It will earn money and reduce the possibility of accidents. With the proper design of hand tools, work posture can be improved and stress can be reduced, resulting in an improved quality of work.

Accidents with hand tools nearly always arise from some human failing – carelessness, not knowing the right tool for the job,

ignorance of safety precautions, or failure to maintain tools and to keep them properly. You need to be correctly instructed in how to use tools and how to look after them.

10.2.1 Selection, use and maintenance

There are basic considerations in selecting, using and maintaining hand tools:

- avoid static load at the shoulder or arm due to the continuous holding of a tool at a raised position or the gripping of a heavy tool;
- avoid awkward wrist angles while using tools such as snips and pliers;
- reduce uncomfortable pressure on the palm or joints of the hand, e.g. from pliers that are too small;
- select the correct weight, size and tool for the job;
- use only tools of good-quality steel – tools made of inferior steel chip and may even shatter when struck, tool heads mushroom, tool jaws open out and cutting tools lose their edge;
- handles should have a smooth finish, should be easy to grasp and should have no sharp edges or corners;
- tools should be firmly fixed and should be regularly checked for splits and cracks; wedges should be checked for tightness of fit;
- tools should be kept free of grease and dirt, and moving and adjustable parts should be well oiled;
- cutting edges should be kept sharp for accurate working and to avoid the need for unnecessary pressure;
- for work on or near electrical apparatus only properly insulated tools should be used;
- tools should be properly stored in boxes, racks, holders or pocket belts and should not be left so that they can fall, roll or be tripped over; cutting edges should be sheathed;

- damaged tools should be immediately repaired or replaced.

Figure 40 illustrates some worn hand tools and those in good condition.

Points to remember:

- Use the right tool for the job.
- Carry tools in tool holders and not in the pockets of your clothing.
- Replace tools, before they wear out.

Discussion

- Think of the hand tools commonly used in construction – how would you classify the risks of each and minimize them?

10.3 Power-driven machinery

10.3.1 Hazards

The use of power-driven machinery on construction sites involves many hazards. Common to many construction machines are in-running nip points where one part rotates against or close to another. Common examples are cog-wheels, chain and sprockets, belts and cylinder drums, and ratchet drives. All nip points should be assumed to be dangerous and should be guarded to prevent approach unless they are enclosed within the machine. Equally dangerous are rotating shafts of whatever diameter and of whatever speed. A common cause of accident is clothing becoming caught and wrapped around the shaft. If the shaft is not inaccessible within the machine frame, then it must be enclosed – a loose tube covering and resting on the shaft is a cheap, convenient and effective method.

Figure 40. Reject worn hand tools – use only those in good condition

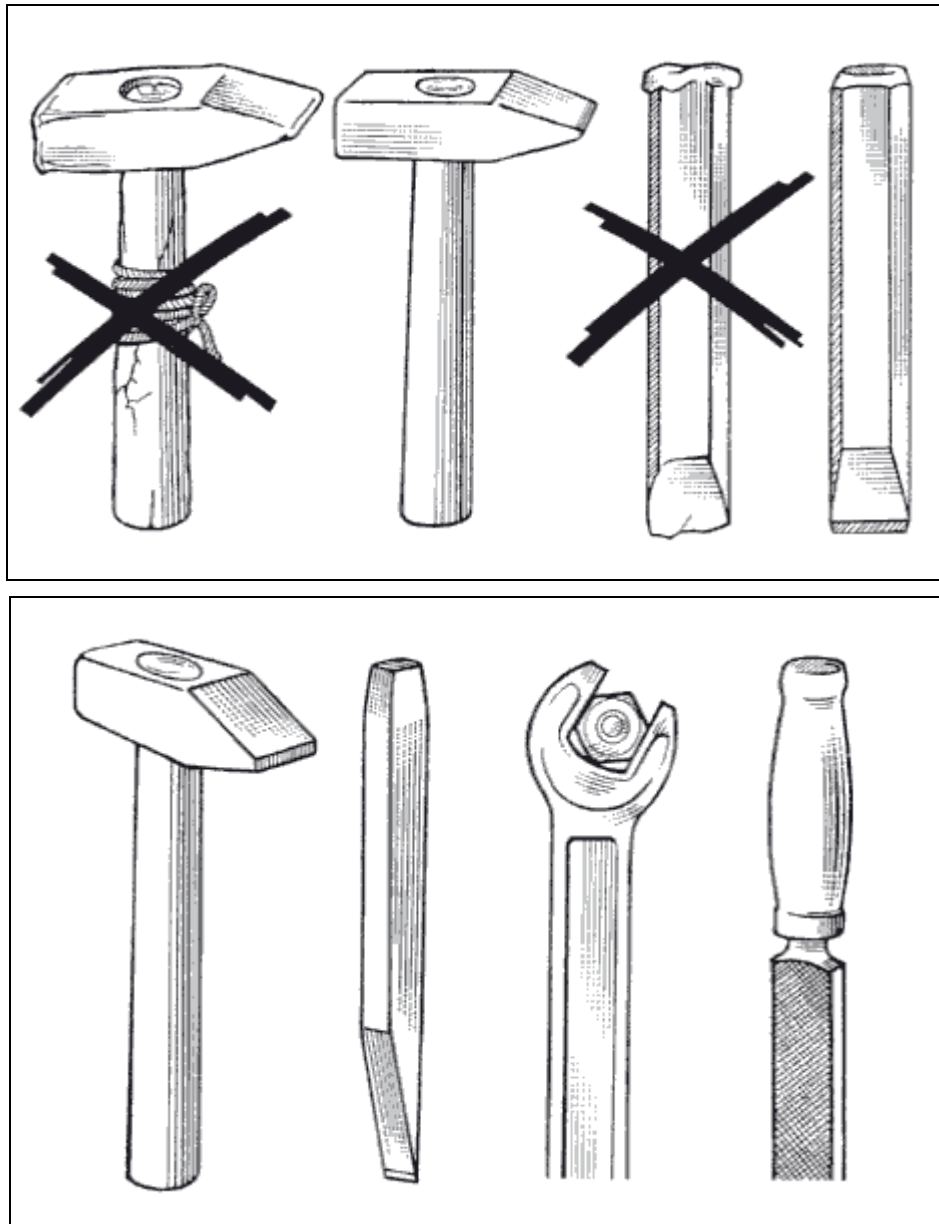

10.3.2 Safety precautions

When you use power-driven construction tools and machinery, make it your regular practice to check whether:

- all protective devices and safety measures supplied with the machine are in position, adjusted and working;
- the machine appears to be safe to use even for an inattentive worker;
- safety devices are strong enough to withstand wear from ordinary use; and

- safety devices do not prevent efficient use of the machine.

If you are not satisfied on any of these points, discuss them with your supervisor.

Point to remember:

- A dangerous part of machinery requires a guard – a warning notice is not a substitute.

10.3.3 Circular saws

Among the most dangerous power-driven machines found on a construction site is the circular saw, mounted in a bench and used for ripping, deep-cutting or cross-cutting. The main causes of accidents are:

- hands coming into contact with the saw blade either above or below the bench;
- timber being thrown back by the revolving blade;
- the blade fracturing or disintegrating.

The top of the blade should be covered by a form of hood which is designed to prevent your hands touching the part of the blade above the wood being cut. It should be adjusted at the front or leading edge of the saw so that it almost touches the surface of the material being cut, leaving no space for a hand to pass through. Behind the blade, and set not more than 12 mm from it at bench level, should be fitted the device called the riving knife. This prevents the cut closing on the back of the blade causing the material to be thrown back at the operator. These features are shown in figure 41.

Parallel to the blade is the fence which acts as a support and guide for the wood being sawn and allows a true cut to be made. It should be locked securely in position before the cut is made.

When hand-feeding material to the saw blade, use a push-stick to keep your hands away from the blade. Use the push-stick also to remove the cut pieces from between the blade and the fence and to remove offcuts from the bench. When you are ripping long lengths of material, they should be supported as they come off the table.

Always keep the saw teeth sharp and properly set. A dull blade is much more likely to break than a sharp one. Never use a blade which is defective in any way.

Points to remember:

- Never leave the saw running after you have used it.
- Always keep the push-stick at the table.
- Never start cleaning above or under the table until the blade has stopped.

Figure 41. Circular saw showing top guard and riving knife behind the saw blade. The top guard is adjusted low over the blade

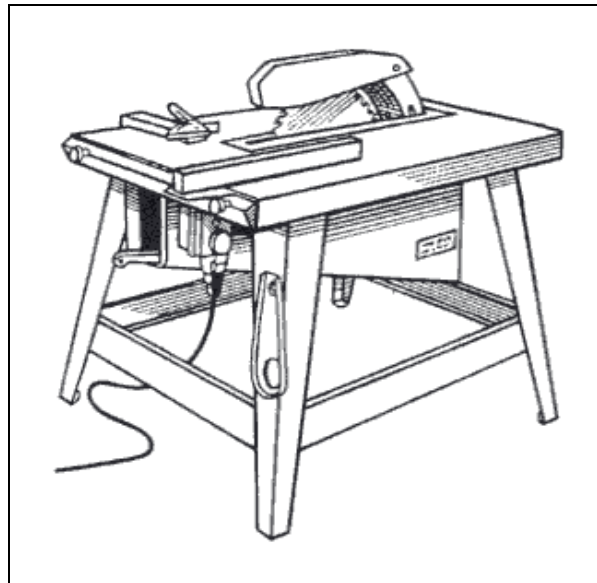

10.3.4 Compressed air tools

If air under compression is allowed to penetrate the skin through a scratch, it can cause painful swelling and may result in serious damage if directed at the eyes, nose or ears. The most common cause of accidents with compressed air is its use to dust off clothing at the end of a working shift. There are also serious injuries caused by workers directing compressed air at a colleague in horseplay.

10.3.5 Cartridge-operated tools

Cartridge-operated tools, which are used for direct fixing to concrete, brick and steel, should be fitted with a guard which does not

allow the tool to be fired until the guard is accurately positioned against the work.

Head and eye, and hearing protection should always be worn (figure 42). The area around the fixing should be cleared of workers in case the material splinters or there is a rejection or a ricochet of the fixing. Firing against too soft or thin material may allow the fixing to penetrate it and injure someone on the opposite side.

The recoil from firing the tool may cause the operator to lose balance – it should never be used from a ladder.

Discussion

- What are the risks associated with power-driven machinery? What would you do to minimize these risks?
- What safety devices would you expect to find on a circular saw, and what is their purpose?

Figure 42. Use of hearing and eye protection by the operator of a cartridge gun, who is also wearing a helmet



10.4 Electrical equipment

Electrical hazards are different from other types of hazard found in construction work because the human senses provide no advance warning, whereas an approaching vehicle may be heard, the prospect of a fall may be seen, or escaping gas may often be smelt.

About one in every 30 electrical accidents is fatal. The great majority of electrical accidents result in electric shock and burns. Fire and explosion from sparks in flammable atmospheres and radiation from electric arc welding or microwave heating are also possible causes of injury.

10.4.1 Electric shock

The danger from electric shock is directly related to the amount of current that passes through the body and to the time that it takes to pass. At lower levels, the effect may be no more than an unpleasant tingle, though perhaps sufficient to throw a worker off balance and cause a fall from a scaffold or ladder. Medium amounts cause increasing muscular tension, so that anything in the grasp can scarcely be released – a condition which can quickly become dangerous. Higher amounts can cause fibrillation of the heart (irregular contractions of the muscles), which is almost invariably lethal.

The passage of current can also cause burning of the skin at the points of contact. Severe burns can occur, too, from exposure to an electric shock without actual bodily contact. Damp and wet conditions greatly increase the danger of electric shock.

It is the voltage that determines the current through the body. Since reduced voltage reduces the severity of electric shock, it is common sense to use reduced voltage of 110 V wherever possible.

The main causes of electric shock are as follows:

- the earth or ground wire becomes disconnected from its plug terminal and touches a live terminal so that the metal case becomes live;
- wrong connections are made to terminals on the plug or the equipment;
- damaged or missing covers on fuse and terminal boxes, or on socket outlets, expose bare live conductors;
- flexible cables are damaged when they are dragged over sharp surfaces or run over;
- makeshift repairs are made to flexible cables with insulating tape alone.

10.4.2 Treatment for electric shock

Switch off the current, but if this is not possible free the victim by using something that is non-conductive, long, clean and dry such as a piece of wood or rubber, or a piece of cloth such as a jacket. Stand on non-conductive material such as a dry piece of wood when carrying out this effort. Do not touch the victim before the current is turned off.

If the victim is not breathing, start artificial respiration, send for help and call a doctor. Continue artificial respiration until the doctor or ambulance arrives (figure 43).

10.4.3 Existing supplies

On any site, power supplies may exist below ground or overhead. As discussed in section 4.2, contact should be made with the appropriate local or electricity authority at the planning stage of the job to determine the route and depth of any underground cables and the safety clearances advised, or if the finished job necessitates their rerouting, for this to be carried out before work commences. Methods of tracing and marking buried electric cables are described in section 4.2.1.

Figure 43. Artificial respiration: Continue mouth-to-mouth resuscitation until medical help arrives



10.4.4 Electrical installations

Electrical installations should be dealt with and serviced only by competent electricians. All forms of electrically operated equipment should be regularly checked and maintained in accordance with the manufacturers' printed instructions. If equipment appears faulty, do not tamper with the electrical part but send for an electrician. Wires and cables to fixed machines should be attached to walls or ceilings, and should not trail over the ground where they are particularly susceptible to damage and to moisture. Do not tie power cables in knots which can cause short circuits and shocks; loop the cable instead. If you are operating a fixed machine, an emergency stop device should be located within your reach.

Before using electrical equipment:

- inspect it for any defects;
- check that the correct plug and fuse have been fitted – never use makeshift connections to equipment, or to plugs, by sticking bare wires into sockets or contacts;
- check that the insulation covering wires and cables is not worn or broken;

- check that there is a good electrical connection at each joint of the earthing system.

Points to remember:

- If an accident is caused by contact with electricity, switch off the current immediately.
- Never work on live wires or cables.

10.4.5 Portable electrical tools and equipment

Double-insulated and all insulated tools are safer than ordinary tools because they incorporate layers of protective insulation to prevent external metal parts from becoming live.

If you use portable power-driven tools, you need to be properly trained in their maintenance and use.

Before operating a portable tool, check it to ensure that:

- there is no damage to the portable leads and plugs – they are subject to heavy wear on construction sites (figure 44);
- there is a correct fuse;
- the tool is set at the right speed for the job;
- leads and cables are kept out of the way of other workers and are not in contact with water.

When you finish using the tool, make sure that the moving part is fully stopped before you put it down.

Figure 44. Electrical installations – pay special attention to the condition of temporary or portable electrical equipment and its cables

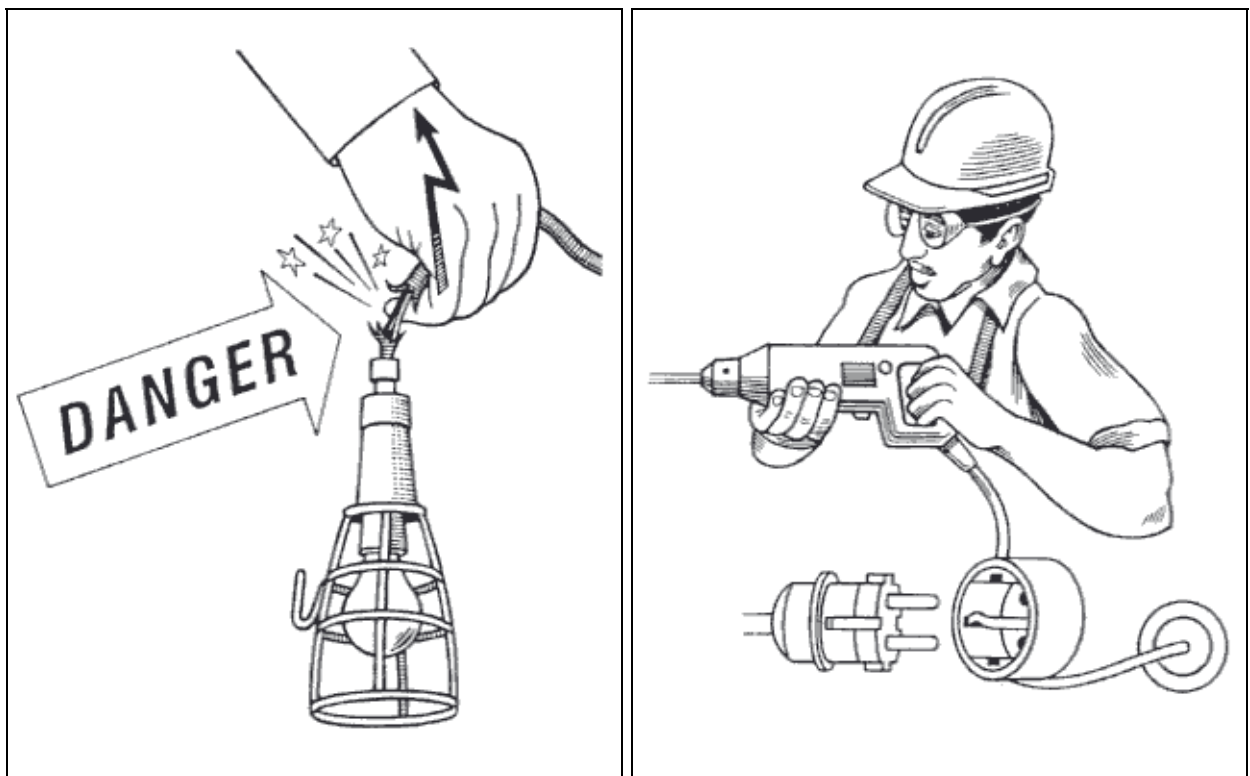

Point to remember:

- Never carry a portable tool by its cable.

Discussion

- Why is electricity particularly dangerous on construction sites?
- What is the first precaution you should consider on a construction site, and why?
- Before you begin to use a portable electric tool, what should you check?
- What are the proper actions to take when a worker has received an electric shock?

10.5 Welding and cutting

The welding and cutting of metal, using both the electric arc and oxyacetylene methods, is a process widely used in construction.

10.5.1 Electric arc welding

Danger from welding is not only to the welder doing the job but also to those working nearby. The risks include eye damage, skin injuries, burns and the inhalation of toxic gases.

The following precautions are necessary:

- The welder and anyone assisting should wear suitable protective goggles or use a face mask or shield to protect the eyes and face from invisible ultraviolet and infrared rays given off by the welding arc.
- Goggles must also be worn when carrying out weld chipping to protect the eyes from flying pieces of slag.
- The welder should wear protective gloves long enough to protect wrists and forearms against heat, sparks, molten metal and radiation. Leather is a good insulator.
- The welder should wear high-top boots to prevent sparks from entering footwear.

- The work area should be screened off with sturdy opaque or translucent materials so that other workers cannot see the arc.
- The workpiece should be well earthed, and all equipment should be earthed and insulated.
- Precautions should be taken against starting fires from sparks from the work area: burning particles are capable of starting a fire 20 m away.

Good practice in electric arc welding is shown in figure 45.

Points to remember:

- It is not enough to protect the welder – think of others working nearby who can see the arc.
- Always switch off the current to the electrode holder when you put it down.
- Remove matches and lighters from your pockets.

Figure 45. Arc welding – workplace earthed, welder wearing personal protective equipment, workplace screened

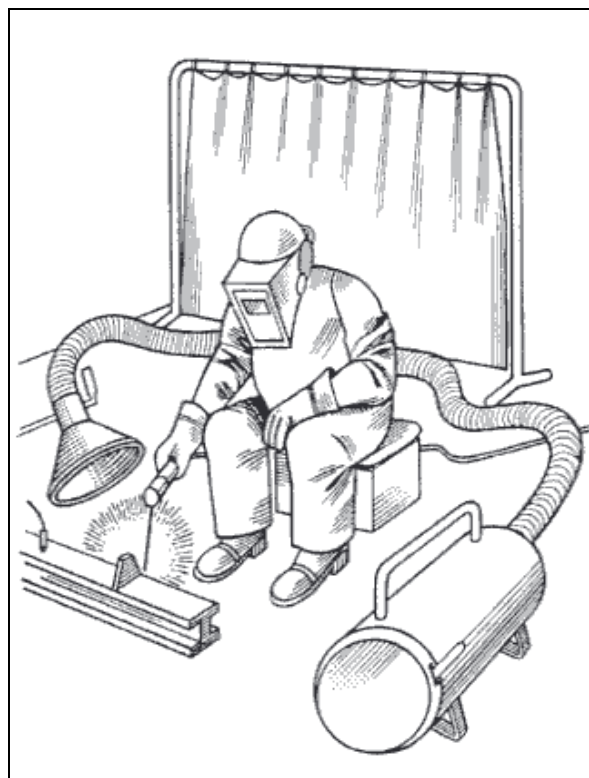

10.5.2 Gas welding

Acetylene and oxygen are normally used in gas welding. The cylinders should be stored separately since any mixture from gas leakages could be highly explosive. They should be kept away from any source of heat and shielded from direct sunlight. If not stored outdoors, the store must be well ventilated. The cylinders in use should be retained upright in a rack or trolley and not left free-standing (figure 46). Flashback arresters should be fitted to the cylinder regulators and non-return valves fitted in the hose connectors at the torch end.

Figure 46. Gas cylinders moved around the site in a trolley in which they are secured upright

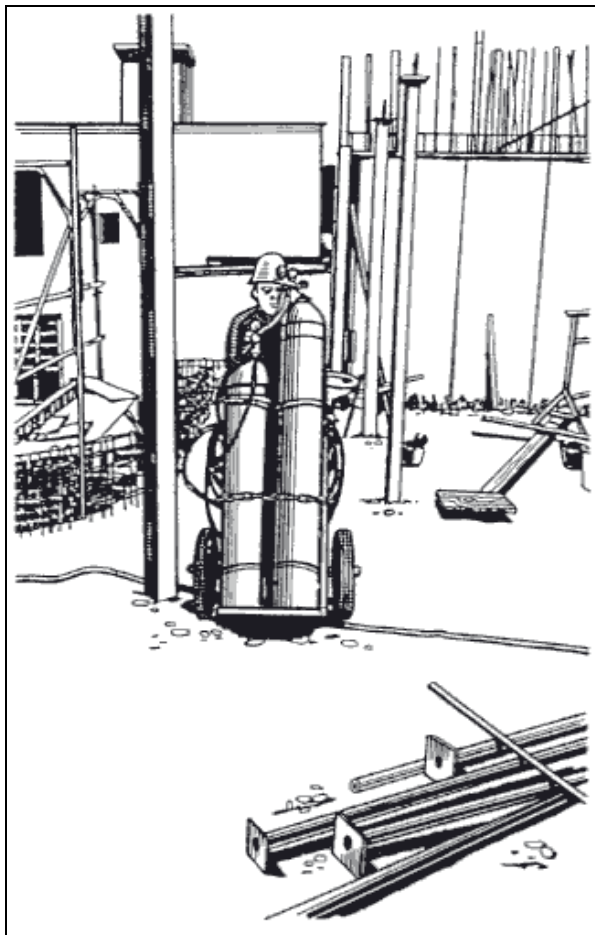

The gas hoses should be in good condition and easily distinguished. They should be protected against heat, sharp objects and dirt, especially oil and grease. These

substances can, even in small amounts, cause an explosive ignition in the event of a leak in the oxygen hose. All joints, especially on the cylinders, should be kept tight. If an acetylene cylinder becomes accidentally heated, shut off the valves, raise the alarm, clear the area of personnel, apply water (if possible, totally immerse) and send for the fire brigade.

Points to remember:

- Turn off all valves on completion of work.
- Never use oxygen to blow dust from clothing.

10.5.3 Fumes

Welding in a confined space, the use of some types of welding rod, or welding on certain painted metals may cause an accumulation of toxic gases and fumes. If local ventilation cannot be arranged, the welder should be provided with respiratory protection and a supply of fresh air. Welding carried out on metals covered with alloys of lead, cadmium, mercury or zinc may lead to a build-up of dangerous fumes requiring exhaust ventilation. Fumes may also be produced from paint and plastic on the surface being welded, and they should first be cleaned off.

Discussion

- What sort of welding do you carry out on site?
- What safety measures are taken and why?

10.6 Liquefied petroleum gases

Liquefied petroleum gases (LPG) are commonly butane or propane, or a mixture of both. LPG, usually sold under trade names, is widely used on construction sites and is a frequent cause of accidents. A leakage of

liquid from a cylinder immediately vaporizes and, because it is heavier than air, flows along the ground and collects in drains, excavations and other low-lying places. As it takes only 2 per cent of the vapour in air to form a flammable mixture, if leakage occurs in a confined space there is a high risk of explosion. Whenever LPG is used indoors, there must be good ventilation.

10.6.1 Storage

LPG stores should conform to the following standards:

- Where LPG cylinders are stored on site, it should be in an open-air compound at ground level surrounded by a fence at least 2 m high; there should be sufficient shelter to prevent cylinders being exposed to extremes of temperature.
- There should be no excavations, drains or basements nearby.
- The compound floor should be paved or compacted level, and kept clear of flammable material, weeds or rubbish.
- Cylinders should be kept at least 1.5 m from the compound fence and 3 m from the site boundary.
- Cylinders should never be stored below ground level or closer than 3 m to cylinders containing oxygen or materials which are toxic or corrosive, e.g. ammonia or chlorine.
- There should be notices stating “LPG – Highly flammable” and prohibiting smoking and naked lights.
- Cylinders, full or empty, should be stored upright with the valve uppermost.
- The valves of empty cylinders should be kept closed, for if they are left open, air will diffuse into the cylinder and may form an explosive mixture.
- There should be a dry powder fire extinguisher at the store.

Point to remember:

- A fire close to a cylinder may cause the LPG to boil and the cylinder to explode, with disastrous consequences.

10.6.2 Handling

When handling LPG cylinders, you should take account of the following points:

- A damaged or leaking valve can have serious consequences.
- When cylinders are not in use, valves and regulators should be protected by appropriate caps.
- When moving cylinders use trolleys, skids or mats and never lift by the valve assemblies.
- Before using a cylinder, ensure that all joints are gas tight by using soapy water and a brush.
- If a leak is detected, move the cylinder as soon as possible to an open space and inform your supervisor at once.
- Cylinders used for heating huts should be kept outside the building.
- If, when lighting a burner, the match or taper goes out before the burner ignites, turn off the burner valve before lighting another match or taper.

Point to remember:

- Whenever you are not using the cylinder, turn off the valve.

11. The working environment

11.1 Chemical substances

A great many chemical substances are used in construction – there is hardly a site without them. They are found in adhesives, cleaning agents for brickwork and stonework, decorative/protective treatments for timber and metals, floor treatments, fungicides, cements and grouts, insulants, sealants, paints, solvents and much else. Of particular importance are solvents, which are liquids commonly used in paint strippers, lacquers, varnishes, surface coatings, thinners and similar cleaning materials.

11.1.1 Chemicals and their risks

Many chemicals are hazardous, with a potential for fire and explosion, or toxic, with an inherent potential to cause poisoning. Toxic substances cause both acute effects, such as dizziness, vomiting and headaches, produced in a short time by exposure to solvents, and chronic effects resulting from exposure over a long period as in lung diseases such as asbestosis and silicosis. Contact dermatitis may result from the contact between the skin

and some chemicals. Acids and alkalis are corrosive and can damage both skin and eyes.

11.1.2 Entry into the body

A chemical can cause injury in various ways depending upon whether it is solid or liquid, or in the form of airborne dust, vapour, fumes or gas. The routes into your body (figure 47) are by:

- inhalation or breathing in. This is the most important route of entry. Some toxic gases and vapours cause irritation in the nose and throat and so give warning of their presence; others do not, and penetrate to the lungs or blood stream. It is the smallest dust particles, those not visible to the naked eye, which reach furthest into the lungs. Inhaled dust accumulates in the lungs, producing changes and causing an incurable disease called “pneumoconiosis”. Breathlessness and inability to work are the eventual consequence. Some dusts such as quartz and asbestos destroy the lung tissue and may lead to the development of tuberculosis or cancer;

Figure 47. Chemicals enter the body by inhalation, ingestion and absorption

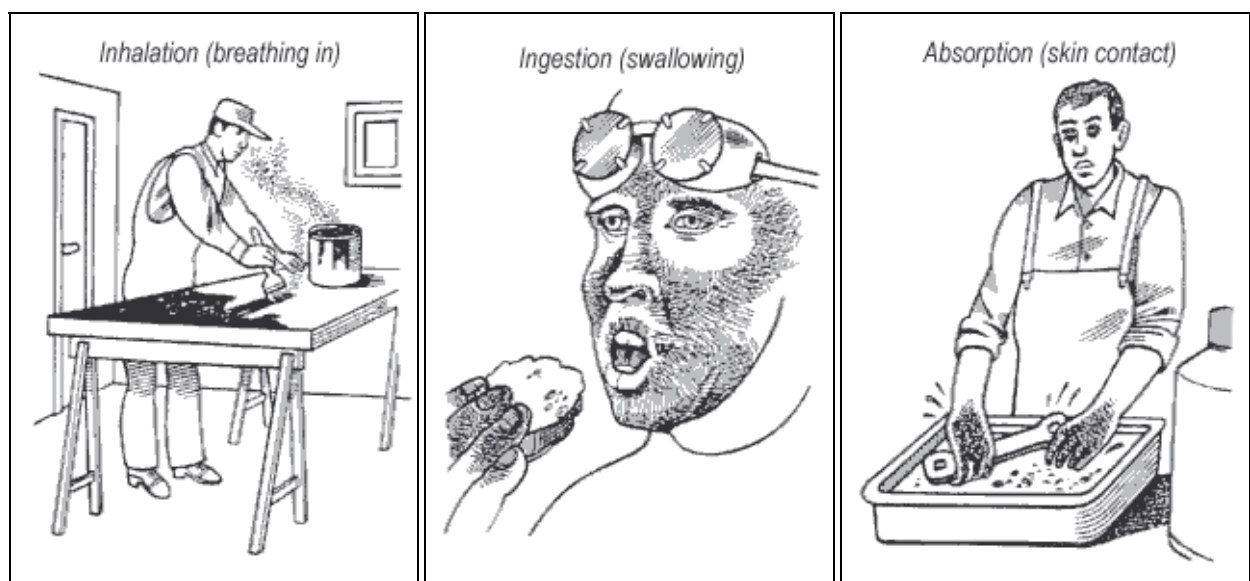

- ingestion or swallowing. This is possible when you handle chemicals such as lead-based paints and then eat or smoke without first washing your hands, when toxic vapours contaminate cups, plates or eating utensils, or when you eat meals at the work site;
- absorption through the skin. Some solvents can be absorbed through the skin into the blood stream and may travel to internal organs such as the brain and liver.

Contact dermatitis or eczema frequently results from the contact between the skin and some chemicals. Acids and alkalis are corrosive and can damage the skin and the eyes on contact. Unless large amounts of water are used at once to rinse the substance off, serious burns will be caused.

Point to remember:

- Some chemical hazards are easy to see or smell. However, there are also chemicals that you cannot see or smell, and which therefore present an extreme danger.

Discussion

- What construction processes cause the most dust?
- What precautions are taken?
- In what construction processes are fumes and vapours most likely to be encountered?
- What precautions have been taken on the site against the risk of inhalation of fumes and vapours?

11.1.3 Preventive measures

Accidents and ill health from the use of chemicals can be prevented if you know what chemicals you are using and the risks they pose, and follow the established safe practice in handling them. Generally, there is an order

of priority in the measures for dealing with hazardous chemical substances:

- Substitute the chemical with a harmless or less hazardous one.
- Enclose the process using the chemical, or provide other engineering controls such as exhaust ventilation; this is often difficult in construction processes.
- Use personal protective equipment (PPE).

If the use of hazardous chemicals cannot be avoided, here are some basic safety measures you can adopt to protect yourself from danger:

- Keep containers of chemicals in a separate and secure store.
- Because two containers look the same, do not assume that they contain the same material.
- Make sure there is a label on the container (figure 48) – if there is no label, then do not use the contents.
- Read the label and make sure you understand what it says, then follow the instructions.
- If the information is not sufficient to tell you how to handle the chemical safely, ask your supervisor for the chemical safety data sheet (figure 49) and do not use the chemical until you have seen it; if you do not understand it, ask questions until you do.
- Check that you are wearing the correct PPE before you handle chemicals (the chemical safety data sheet should say whether you need gloves, eye protection, protective clothing, rubber boots or respirators) and that the equipment is in good order.
- When opening containers, hold a rag over the cap or lid as some volatile liquids tend to spurt up when this is released; transfer the contents of containers in the open air.
- Avoid breathing in any fumes from chemicals. Provide good ventilation, or work in the open air. Leave the work area immediately if you feel dizzy or unwell.

The working environment

- If you are using large quantities of solvents, wear impermeable clothing. Remove any clothing wetted by solvents and leave it to dry in a well-ventilated place.
- Use the smallest quantity of chemicals that is necessary for the particular job.
- Eye protection should be worn when chemicals are being moved or transferred on site.
- When mixing or pouring chemicals using temporary containers, make sure they are suitable and correctly labelled. Never use food or drink containers.
- Wash before you eat and do not eat or smoke at your workstation.
- If the skin is splashed with a chemical, it should be rinsed immediately with plenty of clean running water. Eyes should be

Figure 48. Every chemical used on site should have a label and sufficient information to ensure its safe use

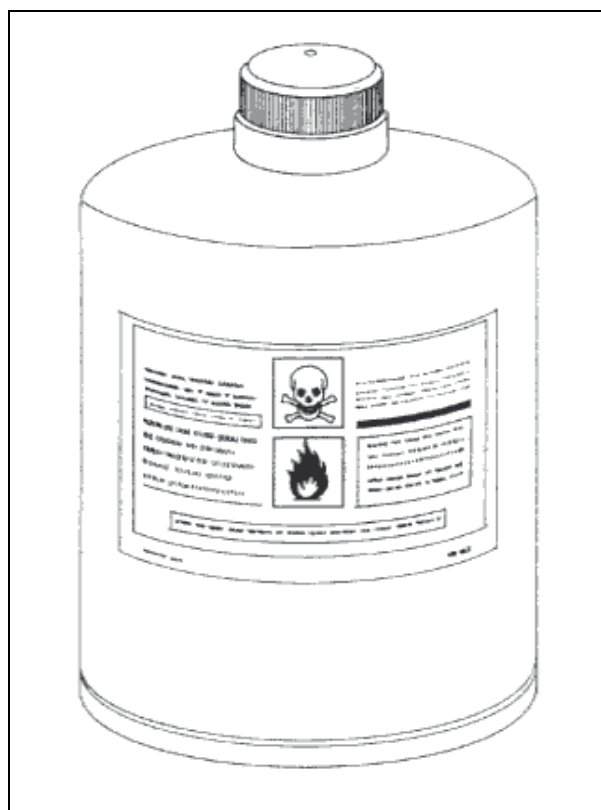

flushed out thoroughly with water and should receive immediate medical attention.

- If you are burned by a chemical, or feel unwell after using a chemical, seek medical attention without delay.
- If there is a spillage of chemicals on the ground or floor, report the matter at once so that the right action can be taken, such as soaking it up with dry sand (figure 50).

Point to remember:

- Never use solvents to remove paint or grease from your skin.

Figure 49. An example of a chemical safety data sheet, providing essential safety and health information

<p>International Occupational Safety and Health Information Centre Tel. + 41 22 799 67 40 Telex: 415 647 ILO CH Telefax: + 41 22 796 62 53</p> <p>International Labour Office</p> <p>ILO-CIS CH-1211 GENEVA 22</p>	<p style="text-align: right;">CHEMICAL INFO-SHEET</p> <p style="text-align: right;">CAS 71-43-2 FORMULA: C₆H₆</p> <p style="text-align: right;">BENZENE</p> <hr/> <p>DESCRIPTION Colourless liquid with sweet odour. Used to produce: - dyes - varnishes - paints - other chemicals Used as a solvent for paints and adhesives. Present in small amounts in gasoline. Industrial uses are decreasing.</p> <p>SHORT-TERM EXPOSURE EFFECTS Inhalation: A 5-hour exposure at 50-150 ppm can cause: - headache - dizziness - confusion A 30-60 minute exposure at 3000 ppm can cause nose and throat irritation. A 30-minute exposure at 7500 ppm can cause death.</p> <p>Eye Contact: High concentrations of vapour cause slight irritation. Liquid causes a slight burning sensation.</p> <p>Skin Contact: Liquid dissolves skin oils and causes irritation and chapping.</p> <p>Ingestion: May cause the same symptoms as inhalation. If swallowed, liquid drawn into lungs can cause severe injury.</p> <p>LONG-TERM EXPOSURE EFFECTS Benzene can damage the blood-forming system causing: - anaemia - infections - bruising - bleeding Prolonged low-level exposure can cause: - hearing damage - dizziness - pallor - problems with vision and balance Respirator skin contact causes: - redness - itching - chapping Known to cause cancer in humans. Cancers of the white-blood cells can develop. Reproductive effects such as menstrual problems may result. Genetic damage can develop after long-term, severe exposures.</p>
<p>FIRE AND EXPLOSION Highly flammable. Dangerous fire hazard. Extinguish fire with: - dry chemical - foam - carbon dioxide</p> <p>CHEMICAL REACTIVITY Normally stable. Contact with strong oxidizers, such as nitric acid, increases risk of fire and explosion.</p> <p>PERSONAL PROTECTION Inhalation: Wear a self-contained breathing apparatus or a supplied air respirator if vapour or mist concentration is unknown or present at any detectable concentration.</p> <p>Skin: Wear, as needed: - gloves - coveralls - boots A suitable material is Viton. Wash a safety shower-eye-wash fountain available in the immediate area.</p> <p>Eyes: Wear chemical safety goggles. A face shield may also be necessary.</p> <p>STORAGE AND HANDLING Follow rules for storing and handling flammable liquids. Store benzene: - in tightly-closed, grounded, labelled containers - in a cool, dry, well-ventilated area - out of direct sunlight - away from incompatible materials and heat. Use non-sparking ventilation, systems and electrical equipment. Use in small quantities in designated areas. Prevent release of vapours into workplace air.</p>	<p>CLEAN-UP AND DISPOSAL Only trained personnel should clean up. Ensure appropriate ventilation is provided. Use spillage protective clothing and respirators. Stop or reduce leak if possible. Absorb small spills with sand or other inert material. Place in suitable, covered containers. Flush area with water. For large spills, contact emergency services and supplier for advice. Comply with environmental regulations.</p> <p>FIRST AID Inhalation: Remove source of benzene or move victim to fresh air. If breathing has stopped, begin artificial respiration.</p> <p>Eye Contact: Flush affected eye with lukewarm, gently flowing water for 20 minutes, holding the eyelid open. Do not rinse contaminated water into non-affected eye.</p> <p>Skin Contact: Remove contaminated clothing. Gently blot or brush away excess chemical residue. Wash gently and thoroughly with water and non-abrasive soap.</p> <p>Ingestion: Never give anything by mouth if victim is: - losing consciousness - unconscious - comatose Rinse mouth thoroughly with water. Have victim drink about 250 mL (8 oz.) of water. DO NOT INDUCE VOMITING. If vomiting occurs, have victim lean forward and repeat administration of water.</p> <p>Note: Obtain medical attention IMMEDIATELY for all serious exposures. Consult a physician or the nearest Poison Control Centre.</p> <p>NEED MORE INFORMATION? See CHEMINFO record no. 178E, Chemical Hazard Summary No. 34, available from CCOHS.</p>
<p><small>This document was originally published by CCOHS (Canadian Centre for Occupational Health and Safety) in its Chemical Information series. Further information can be obtained from CIS or its national centres.</small></p>	

Figure 50. Chemical spillage soaked up with dry sand

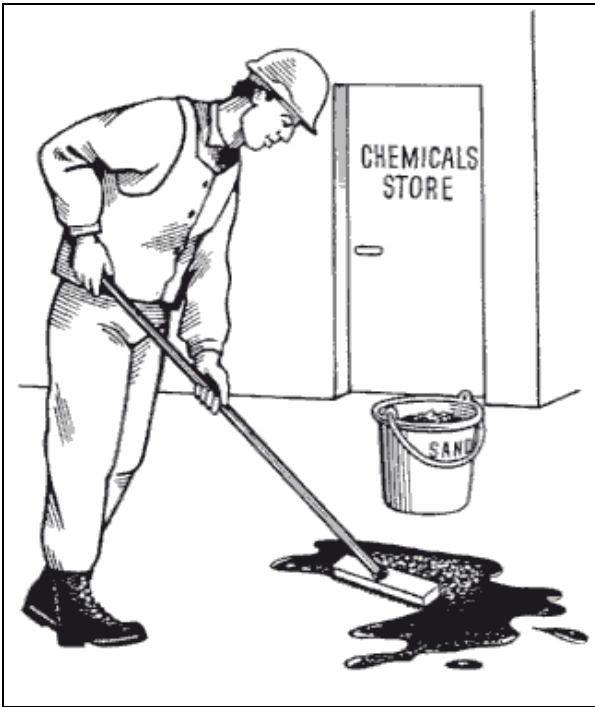

11.1.4 Highly flammable chemicals

Many chemical substances used in construction are highly flammable as well as toxic. The following precautions should be followed when handling or using them:

- Study the label and the instructions on the chemical safety data sheet about safe handling and first-aid measures.
- Remember that all flammable liquids give off vapours which travel unseen into the air and are easily ignited. Never smoke if there are flammable chemicals in the area. Find out what action to take in the case of fire.
- Keep containers in the store until required for use, and return them there when you have finished with them. Store drums upright.
- Treat empty drums with as much care as full ones – they will still contain flammable vapour.
- Always transfer the contents of large containers to small containers in the open air.

- Use funnels and spouts to prevent spillage. Soak up any spillage with dry sand and remove the contaminated sand to a safe place in the open air.
- If you cannot avoid using highly flammable liquids in an enclosed area, make sure there is an adequate supply of fresh air. This can usually be achieved by opening windows and doors to the full. If it is necessary to use a fan, check that the fan is electrically safe to use in a flammable atmosphere.

Discussion

- How would you recognize whether toxic or dangerous chemicals are being used on your construction site?
- Have you or anyone you know shown symptoms or suffered from using chemicals? If so, what were they?
- What steps do you think could have been taken, and were not taken, to prevent these ill-effects?
- What flammable chemicals have you used on construction sites?

11.2 Hazardous substances

11.2.1 Cement

Cement mixes are a well-known cause of skin disease. Both irritant and allergic contact dermatitis can result from proximity to wet cement. Prolonged exposure to wet cement (for example, if you kneel or stand in it) may cause cement burns or ulceration of the skin. The following precautions should be taken:

- Avoid breathing in cement dust, as well as dust created by the surface treatment of hardened concrete which may contain a high silica content, by wearing suitable respiratory protective equipment.
- Protect the skin from contact by wearing long-sleeved clothing and full-length

- trousers, with rubber boots and gloves when required.
- Protect the eyes; if any cement gets into the eyes, rinse them immediately with plenty of warm water.
 - Immediately wash off any dust or freshly mixed cement that gets on to the skin.
 - Clean off your clothing and boots after work.

11.2.2 Asbestos

Breathing in asbestos dust can kill by causing irreversible lung damage and cancer. There is no known cure for asbestos-related diseases. The more asbestos dust breathed in, the greater the risk to health. There are control limits for the various types of asbestos. You are likely to find asbestos in the following situations:

- (a) as asbestos insulation or coating used for:
 - (i) thermal insulation of boilers;
 - (ii) fire protection of structural steelwork;
 - (iii) thermal and acoustic insulation of buildings;
- (b) as asbestos insulating board used in a wide variety of places such as:
 - (i) fire protection on doors, protected exits, structural steelwork, etc.;
 - (ii) cladding on walls, ceilings, etc.;
 - (iii) internal walls and partitions;
 - (iv) ceiling tiles in a suspended ceiling;
- (c) as asbestos cement, which is found as:
 - (i) corrugated sheets (roofing and cladding of buildings);
 - (ii) flat sheeting for partitioning, cladding and door facings;
 - (iii) gutters and downpipes.

Before starting work

If it is not clear whether insulating material, boarding, and so on contain asbestos, bulk sampling and laboratory analysis are necessary. This must be done by someone with

suitable training and experience. Alternatively, you may assume that the material contains crocidolite (blue), amosite (brown) or chrysotile (white) asbestos and take appropriate precautions.

Before starting any work with asbestos, an adequate assessment must be made to work out the precautions needed to control the exposure to the substance. Work with asbestos may range from cleaning brake drums of construction plant and vehicles to full-scale asbestos removal.

Carrying out work with asbestos

In many countries those who work with asbestos to any extent, and in particular in removing and disposing of asbestos, require to be licensed or to hold a permit. In working with asbestos insulation board, workers will probably need to wear suitable protective clothing. Only working methods that keep asbestos dust levels as low as possible should be used (e.g. use hand tools and avoid breaking boards).

Asbestos cement is less likely to generate dust than many other asbestos products, but the risk of asbestos dust release is still present.

When cutting asbestos cement, use hand tools (or power tools fitted with exhaust ventilation equipment). Where it is not possible to keep asbestos dust levels under control limits, respirators should be worn. Protective clothing will probably be required for any significant work with asbestos cement. If you have to clean asbestos cement sheeting encrusted with lichens or mosses, a system of wet scraping/brushing is preferred.

Methods of limiting exposure to asbestos dust include:

- removing asbestos materials before starting major demolition work. This prevents accidental exposure to asbestos;
- wet methods of removal (to suppress dust);

- prompt removal and bagging of waste asbestos, and disposal at an approved waste disposal site;
- separating asbestos work areas from other general work areas.

Point to remember:

- The dust you cannot see is more dangerous than the dust you can see.

11.2.3 Lead

Inorganic lead is found in many construction products, e.g. electricity cables, pipes, gutters and old lead sheet roofs. Organic lead is added to motor fuels, and storage tanks will be heavily contaminated.

There is a risk to health from inhaling dust or fumes created by burning or cutting materials containing lead, including painted surfaces, by welding, by grinding or cutting, and by spray painting of leaded paints. Lead can be absorbed when swallowed, usually when food is contaminated, and adequate washing facilities should be provided. Organic lead compounds are readily absorbed through the skin.

Excessive lead absorption causes constipation, abdominal pain, anaemia, weak muscles and kidney damage. It can also affect the brain, causing impaired intellect, strange behaviour, fits and coma. If you work with lead in any form, you should take the following precautions:

- Wash your hands regularly, and always before eating; you are at higher risk if you smoke with lead on your hands.
- Use the protective clothing and respiratory protective equipment which should be provided whenever lead levels exceed national control limits.
- Wear work clothing on the job and store your “street” clothing where it cannot be contaminated by your work clothing.

Point to remember:

- Wash thoroughly and if possible change out of work clothing before you leave the site, otherwise you may be taking dangerous dust and dirt into your home.

Discussion

- What precautions have been taken at the site to prevent exposure to hazardous substances?
- Where asbestos is known or suspected to be present at the site, are adequate steps taken to prevent workers from being exposed to the dust?
- Have you noticed or heard any of your co-workers complain of symptoms which you think might be related to or caused by exposure to hazardous substances?
- Can you think of any other hazardous substances used on construction sites?

11.3 AIDS

AIDS (Acquired Immune Deficiency Syndrome) is a disease caused by a virus that attacks the body’s natural defence system, allowing the development of illnesses and infections which would not otherwise have occurred. The virus is transmitted by sexual intercourse with an infected person or by injection or contamination with infected blood.

It is not transmitted by normal social contacts such as touching an infected person, sharing toilet and washroom facilities, crockery or cutlery.

11.3.1 Precautions

A danger of AIDS exists for workers who may be cut or wounded by infected

needles or razor blades found during construction work, e.g. in disused buildings in high drug abuse areas.

If you think you might cut yourself on sharp items which may be infected, take care by wearing heavy-duty gloves and overalls. Remove old syringes, needles and razor blades with disposable tongs, put them in puncture-proof bins and seal them. Your supervisor should make local arrangements to have the bins incinerated.

Clear up blood or other spillages with a solution of strong disinfectant. If splashing from infected fluids is likely (e.g. during sewer repair), protective clothing, including goggles, should be worn.

11.3.2 First aid

Your employer should provide sufficient training and information about first-aid treatment.

Cuts or abrasions should be covered with waterproof dressings. In the case of injury, thoroughly irrigate the wound and wash it with soap and water before dressing it. Always wash your hands after treating a wound. In more serious situations involving open-wound injury, prompt attention is important, and sensible first-aid procedures should be applied before sending the person for more expert treatment.

The AIDS virus has been shown to be present in saliva and this has caused anxiety among first-aiders. No cases of AIDS have been reported anywhere by transmission of the infection from saliva. Nevertheless, a portable mouth-to-mouth resuscitation device incorporating a one-way valve can be used.

AIDS generates fear because it is a new disease and many questions about it cannot yet be fully answered. It is not highly infective when compared with other diseases such as hepatitis B, which may be contracted in a similar fashion. The modes of transmission are known and infection has not been associated

with any particular occupation, including the construction industry.

11.4 Noise and vibration

Construction sites are noisy places. Excessive exposure to loud noise can cause permanent damage to your hearing. Noise at work can cause stress, making it difficult to sleep. Very high levels of noise caused, for example, by using cartridge tools can cause instantaneous hearing damage.

The levels of noise produced in operations such as piling, tunnelling and cleaning operations may be such that unprotected persons will exceed their maximum recommended daily dose in a matter of seconds. Even a few minutes' exposure every day to very noisy machines can be enough to start permanent hearing damage. Loud noise can cause a temporary partial loss of hearing, with recovery time varying from 15 minutes to several days depending on the noise level. There may also be a "ringing" in the ears which should be regarded as a warning – temporary loss may become permanent with repeated exposure. Deafness develops very gradually but cannot be cured once the damage has been done.

Noise also makes it difficult to hear sounds that you need to hear such as work signals and warning shouts.

11.4.1 Noise control

There are several steps that can be taken on site to reduce noise:

- Check that exhaust outlets are fitted with silencers or mufflers, and do not keep machinery running unnecessarily.
- Keep compressor motor covers closed when they are running (figure 51).
- Check that concrete breaker mufflers and similar devices are securely fitted (figure 51).
- Check that machinery panels are secured and do not rattle.

- Ensure that sound-insulating screens are provided to reduce noise from stationary plant, and that where practicable noisy machinery is sited behind earth mounds or brick stacks to isolate or screen it as far as possible.

Figure 51. Compressor noise control – keep covers closed, use muffler on pneumatic hammer and wear hearing protectors

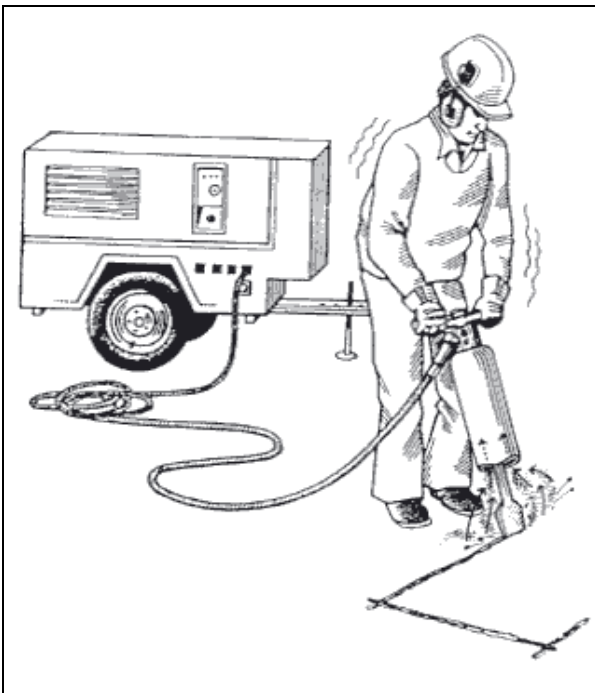

- insert ear plugs with clean hands;
- look out for damage: if the earmuffs no longer fit properly or the seals have become hard or damaged, ask for a replacement.

It is not true that ear protectors make it more difficult to understand speech or hear warning signals, as they reduce both unwanted noise and alarm signals equally; the signal can actually be heard more easily.

Point to remember:

- If you have to shout to make yourself heard by someone about 1 m away, there is a noise problem requiring action.

Discussion

- List the sources of noise on site which affect you.
- Could noisy machines be separated from other work?
- What steps could be taken to reduce noise from noisy machines that you use?
- What problems can deafness cause?

11.4.2 Hearing protection

If you are working at or near a noisy machine:

- ask if noise levels have been measured, and what those measurements are;
- remember that noise which is continuous at a level of 85-90 decibels (dB(A)) or more is injurious to hearing;
- ask for appropriate earmuffs or ear plugs if you work with or near a noisy machine and make sure they fit properly and are comfortable (figure 51);
- wear them all the time you are in a noisy part of the site;
- keep your hearing protection clean and in a safe place when you are not using it;

11.4.3 Vibration

Many noisy machines or hand-operated tools also transmit vibrations to the body – pneumatic rock drills or concrete breakers are common examples. In this way they can injure muscles and joints, and affect blood circulation causing what is known as “white finger disease”. When using these tools you should wear gloves, which help to cushion the vibrations.

11.5 Lighting

All parts of the site need to be properly lit by natural or artificial means whenever work is going on. Site lighting is always

necessary in those areas short of natural light such as shafts and enclosed stairways. Artificial lighting should be placed to avoid deep shadows – these may conceal hazards which would be obvious in good light. Mounting of lights should be as high as practicable to avoid glare, and lights should be placed so that workers do not have to work in their own shadow.

Only robustly installed fittings which are well out of reach, such as floodlighting, should be at full mains voltage. Temporary electric lighting should be installed by trained electricians using low-voltage equipment. You can assist in its safe use in the following ways:

- Do not interfere with the installation.
- Report any damaged insulation, on broken bulbs, lampholders or fittings.
- Make sure that cables are fastened well off the ground and do not let cables or connections trail in wet conditions.
- Do not change bulbs yourself.

Point to remember:

- When moving from a very bright area to shaded area, give your eyes time to adjust.

11.6 Exposure to heat and cold

11.6.1 Hot weather

Workers on construction sites are often exposed to all weathers. In tropical countries radiation from the sun, with high air temperatures and humidity, increases fatigue from heavy work and causes heat stress which may lead to heat exhaustion and heatstroke, the latter a medical emergency, and to ill health. The effects of heat combined with physical workload tend to accumulate.

Good welfare facilities are essential to health in hot climates, and the suitable

arrangement of working time is important. There should be:

- sufficient work breaks: for moderately heavy or heavy work 50 per cent or more rest time is essential;
- rest areas away from workstations to cool off;
- an adequate supply of clean, cool drinking-water: drink often and in small quantities;
- washing facilities provided to keep work clothes clean.

11.6.2 How to keep cool

It is helpful to learn how to keep the body cool:

- Keep out of direct sunlight as much as possible.
- Avoid unnecessary quick movements.
- Ensure that there is air circulation in operators' cabins.
- Avoid wearing tight clothes or those which prevent evaporation of perspiration such as some plastic materials.
- Wear head protection.
- Take cool drinks regularly to replace moisture lost through perspiration.
- Add salt to food or eat food that contains natural salt.
- Find a shady place for rest pauses.

Point to remember

- If the urine you pass is less than usual and strong and dark in colour, you are not drinking enough water to replace loss through perspiration.

11.6.3 Cold weather

Cold is not just uncomfortable – it may affect health and judgement. Although not a serious problem in tropical climates, it may nevertheless be experienced at high altitudes and in the early morning at sites which are well inland.

Some of the hazards of cold weather are as follows:

- There are more likely to be accidents if the temperature of the hands falls below 15° Celsius: there is loss of concentration and coordination.
- Workers repeatedly using vibratory tools such as rock drills may suffer “white finger” syndrome involving sensory loss as a consequence of cold.
- Prolonged exposure to temperatures around freezing may cause frostbite or hypothermia.
- Wind can affect temperature. When the air temperature is 10° Celsius and the wind speed is 32 km per hour, the temperature, so far as the body is concerned, falls to freezing. This is called the chill factor.
- Even where the temperature is above freezing point, a condition called “immersion foot” can occur in wet conditions if the feet are not kept dry.

Point to remember:

- If someone appears to be suffering from immersion foot or hypothermia, move him or her into a warm place and allow slow recovery. Sudden warming may increase the injury.

11.6.4 How to keep warm

The following points should be considered when working in cold conditions:

- Choose clothing which allows moisture to escape but does not allow wind and rain to penetrate: waterproof clothing tends to prevent evaporation of moisture.
- Avoid bulky clothes, as they hamper movement – a number of layers of clothing are preferred.
- Hands and feet are particularly susceptible to cold.
- Use facilities for preparing hot meals and drinks, and for storing and drying clothing.

12. Personal protective equipment (PPE)

12.1 Why do you need PPE?

The working conditions in construction are in most cases such that, despite all preventive measures in project planning and work design, some personal protective equipment (PPE), such as a helmet, hearing and eye protection, boots and gloves, is needed to protect workers. However, there are disadvantages in using PPE:

- Wearing some forms of PPE may involve discomfort to the user and slow down the work.
- Extra supervision is called for to see that PPE is worn.
- PPE costs money.

Wherever possible, it is better to try to eliminate the hazard rather than providing PPE to guard against it.

Some PPE such as safety helmets and footwear should be used on all construction sites. The need for other PPE will depend on the sort of work you do. Remember, too, that proper work clothes will provide protection for the skin.

Point to remember:

- It is safer and in most cases cheaper to eliminate hazards than to provide personal protective equipment.

Discussion

- What hazards are there on construction sites which could be removed instead of using PPE?
- How could you make people wear PPE when it is needed?
- Why is PPE often uncomfortable?

12.2 Head protection

Falling objects, overhead loads and sharp projections are to be found everywhere on construction sites. A small tool or bolt falling from 10 or 20 m high can cause serious injuries or even death if it strikes an unprotected head. Head injuries often occur when moving and working in a bent position, or when arising from such a position.

Safety helmets protect the head effectively against most of these hazards, and you should wear a helmet whenever you are on site and particularly when you are in an area where overhead work is going on. These areas, known as “hard-hat areas”, should be clearly marked with safety signs at entrances and other suitable places (figure 52). The same rule applies to managers, supervisors and visitors. Only safety helmets which have been tested to national or international standards should be used. A chin-strap on the helmet prevents it from falling off and should be used when appropriate.

Point to remember:

- Your safety helmet protects you only if you have it on.

12.3 Foot protection

Foot injuries fall into two broad types: those due to penetration of the sole by nails which have not been knocked down or removed, and those due to crushing by falling materials, which can be minimized by wearing protective footwear. The type of safety shoes or boots to be used will depend on the nature of the work (e.g. the presence of ground water on construction sites), but all safety footwear should have an impenetrable sole and uppers with a steel toe-cap.

Figure 52. “Hard-hat” areas – all or most parts of construction sites should be marked by signs as “hard-hat” areas

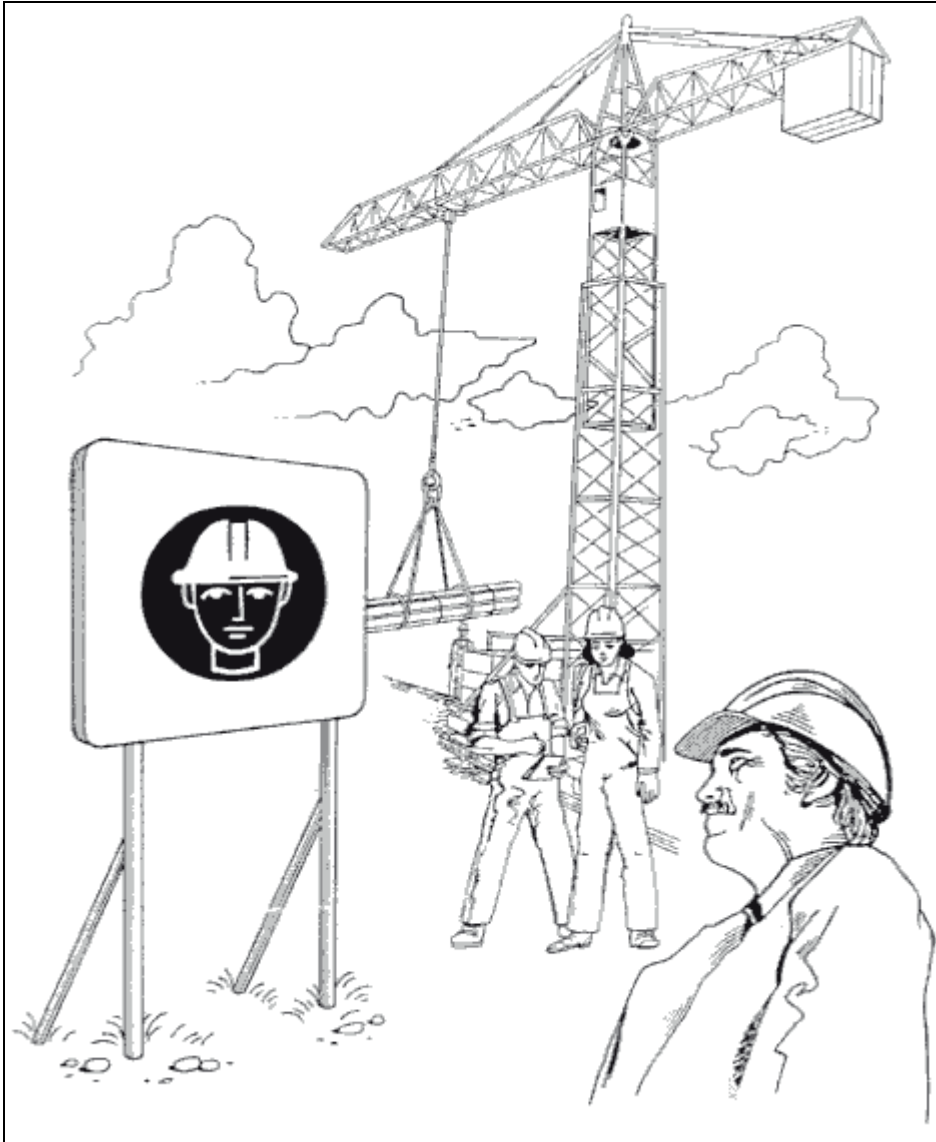

There are many types of safety footwear now available such as:

- light, low-cut leather safety shoes for climbing jobs;
- normal safety shoes or boots for heavy-duty work;
- rubber or plastic safety wellingtons or gumboots which provide protection against corrosive substances, chemicals and water.

Point to remember:

- There are designs of safety footwear to suit all needs.

Discussion

- Should the wearing of safety footwear and safety helmets be a rule for everyone on site?

12.4 Hand and skin protection

Hands are extremely vulnerable to accidental injury, and in construction more injuries are caused to hands and wrists than to any other part of the body. Open wounds, abrasions, fractures, dislocations, strains, amputations and burns occur. They are largely preventable by better manual handling techniques and equipment, and by wearing suitable hand protection such as protective gloves and gauntlets.

Among the common hazardous tasks where hand protection should be provided are:

- operations involving contact with rough, sharp or jagged surfaces;
- contact with or splashes from hot, corrosive or toxic substances such as bitumen and resins;
- working with vibratory machines such as pneumatic drills where some cushioning of the vibrations is desirable;
- electrical work in humid and cold weather.

Skin trouble is common in the construction industry. Contact dermatitis is the commonest type of skin disease. It feels itchy and looks red, scaly and cracked, and can become so bad that it affects your ability to continue working. Wet cement is one of the main skin hazards, but other substances include tar and pitch, which can cause skin cancer after prolonged exposure, paint thinners, acids for masonry cleaning and epoxy resins. In addition to gloves, use barrier creams and wear long-sleeved shirts, full-length trousers and rubber boots.

Point to remember:

- If you notice any skin trouble, report it to your supervisor at once.

Discussion

- What common tasks in construction produce hand injuries?
- What could be done to avoid or minimize the dangers?
- Are there any risks attached to the wearing of gloves?

12.5 Eye protection

In industry many eye injuries occur as a result of flying material, dust or radiation when the following jobs are being carried out:

- breaking, cutting, drilling, dressing or laying of stone, concrete and brickwork with hand or power tools;
- chipping and dressing painted or corroded surfaces;
- cutting off or cutting out cold rivets and bolts;
- dry grinding of surfaces with power grinders;
- welding and cutting of metals.

In some industrial processes there may also be a risk from the spillage, leakage or splashing of hot or corrosive liquids.

Some of these hazards can be removed permanently by proper machine guarding, exhaust ventilation or work design. For many hazards, for example, stone cutting or dressing, personal eye protection (goggles, safety glasses or shields) is the only practical solution. Sometimes workers are aware of the danger they run and the consequences if their eyes are damaged, but do not wear eye protection. This is because the type chosen interferes with vision or is uncomfortable to wear, or is not immediately at hand when needed (figure 53).

Figure 53. Eye protection must be suitable, comfortable and available to encourage workers to wear it



Point to remember:

- Ninety per cent of all eye injuries can be prevented by suitable eye protection.

Discussion

- Which jobs on your site require eye protection?
- How would you convince employers to provide eye protection and workers to wear it?
- What different types of eye protection are needed by workers doing the various tasks carried out during construction?

12.6 Respiratory protection

On construction sites there are often tasks where harmful dust, mist or gas may be present, such as:

- rock crushing and handling;
- sandblasting;
- dismantling buildings containing asbestos insulation;
- welding or cutting materials with coatings containing zinc, lead, nickel or cadmium;
- paint spraying;
- blasting.

12.6.1 Correct choice of respirator

Whenever there is doubt about the presence of toxic substances in the atmosphere, a respirator must be worn. The correct type of respirator will depend upon the hazard and the work conditions, and you need to be trained in its use, cleaning and maintenance. Advice on suitable types of respirator and filter should be sought from appropriate safety and health authorities.

The simplest masks are disposable paper types. Remember that these are only effective against nuisance dusts.

There are three types of half-face mask with filters (figure 54):

- for protection against airborne particles, e.g. stone dust, with a coarse filter fitted in the cartridge (note, these filters have a specific lifetime and should be changed as necessary);

- for protection against gases and fumes, e.g. when using paints containing solvents, with a filter containing activated carbon;
- a combination filter containing both a dust and a gas filter. Cartridges must be replaced regularly.

A full-face mask can be fitted with the same types of filter, and it also protects the eyes and face.

Self-contained breathing apparatus with a full-face mask fed with air at positive pressure always gives the best protection, and must be used in confined spaces and whenever a sufficient supply of air or oxygen at the working place is in doubt. The air may be supplied from a compressor with a filter, or air/oxygen bottles (figure 55). In a hot climate, the full-face type is the most comfortable mask because it is looser fitting around the face and the air itself has a cooling effect. Users must be trained in the use of self-contained breathing apparatus and must keep to the manufacturers' specifications.

Points to remember:

- Respirators which are of the wrong type and not properly fitting are positively dangerous.
- Filters and canisters have a useful lifetime. Follow the specification and do not be tempted to use the respirator beyond its stated lifetime.

Figure 54. Three types of half-face mask with filters

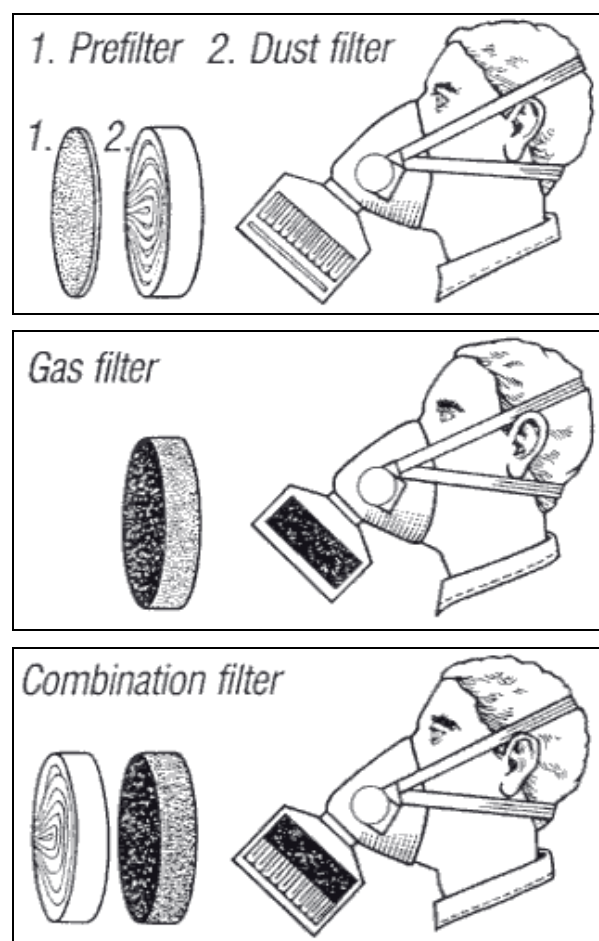
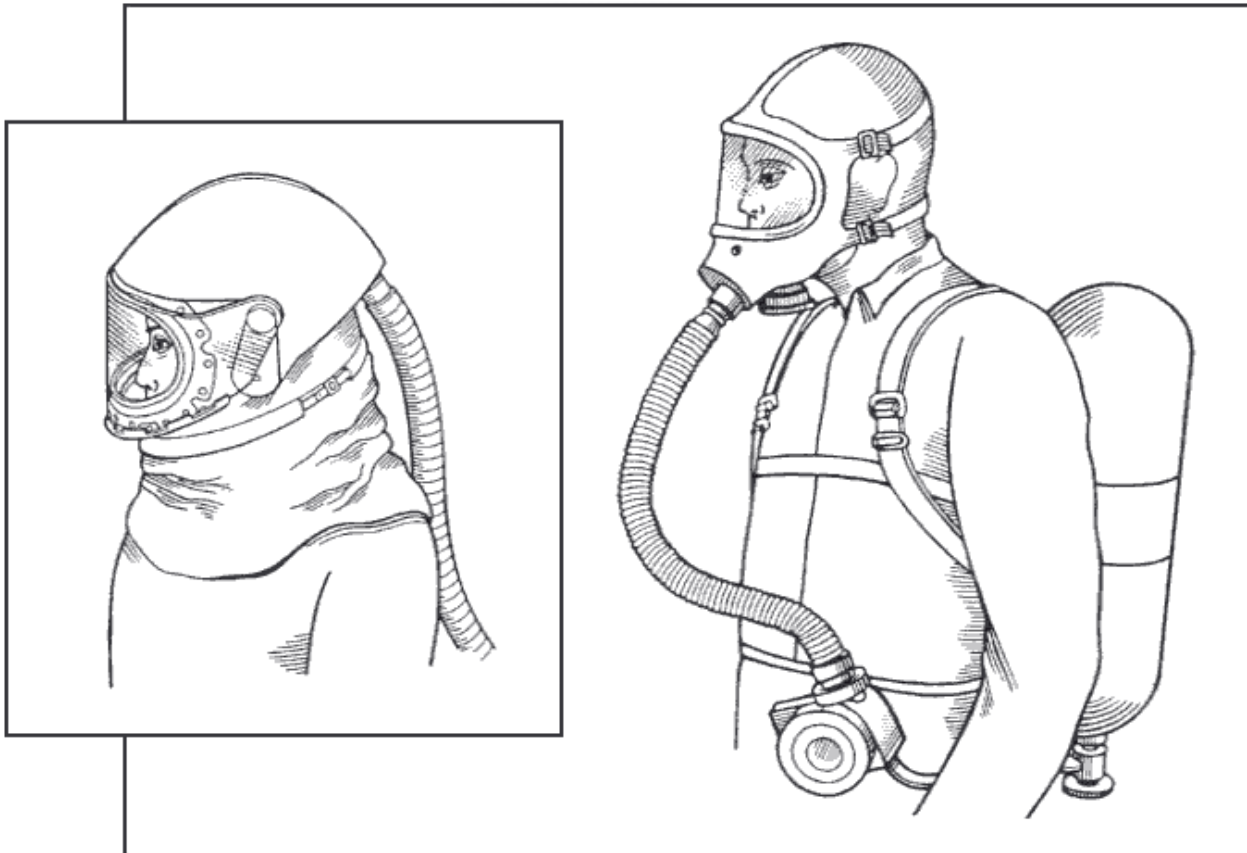

Figure 55. Self-contained breathing apparatus, with air supplied from either a compressor or air bottles



12.7 Safety harness

The majority of fatal accidents in construction are due to falls from heights. Where work cannot be done from a scaffold or ladder, or from a mobile access platform, the wearing of a safety harness may be the only way to prevent serious injury or death.

Circumstances in which a safety harness may be worn were discussed in Chapter 7. Another common situation in which a safety harness may be used – sometimes supplemented by the use of a safety net – is maintenance work on steel structures such as bridges and pylons.

There are many types of safety belt and safety harness available. The manufacturer or supplier should be asked for advice on suitable types for the intended purpose and for instructions on use and maintenance. A full

safety harness should always be used in preference to a safety belt.

A safety harness and its lanyard must:

- limit your fall to a drop of not more than 2 m by means of an inertia device;
- be strong enough to support your weight;
- be attached to a strong structure through a firm anchorage point above the place at which you are working.

Point to remember:

- Make a habit of using the safety harness provided.

Discussion

- Which jobs on your construction site need a safety harness?
- Why are they not used?

13. Welfare facilities

13.1 Why welfare facilities?

Work in the construction industry is arduous; it involves much manual or physical activity. It is also hazardous and dirty. Good welfare facilities not only improve workers' welfare but also enhance efficiency.

Welfare facilities such as the provision of drinking-water, washing, sanitary and changing accommodation, rest-rooms and shelter, facilities for preparing and eating meals, temporary housing, assistance in transport from place of residence to the work

site and back, all help to reduce fatigue and improve workers' health (figure 56). The facilities may be provided and maintained by one contractor for all workers or by individual contractors.

Point to remember:

- Welfare facilities improve morale and consequently improve efficiency.

Figure 56. Suitable washing facilities and lavatories help protect the health of workers

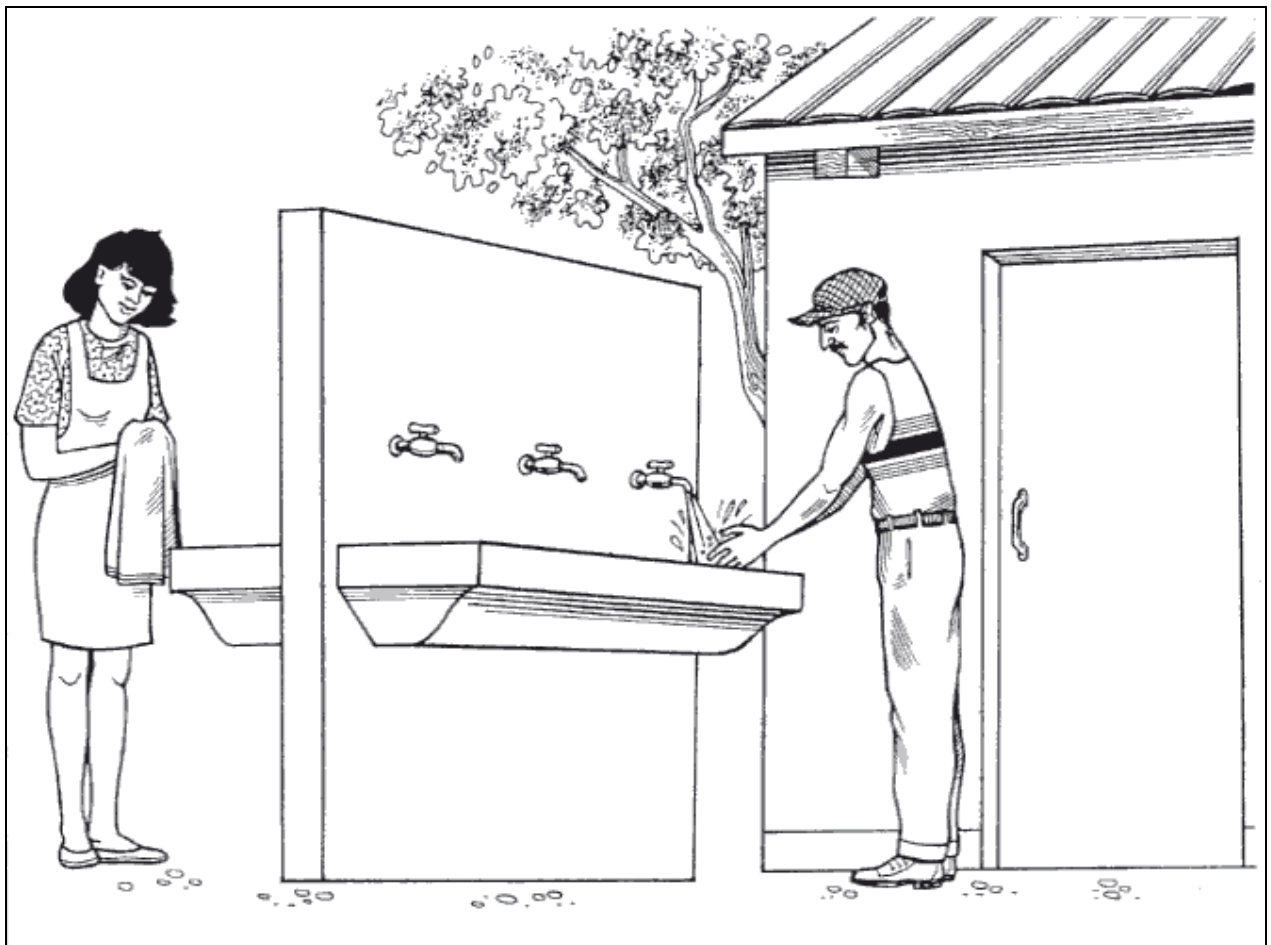

13.2 Sanitary facilities

National laws usually prescribe the type, number and standard of sanitary facilities which should be provided, but as a general guide the following should be regarded as a practical minimum:

- a sufficient number of water flush-type lavatories for men when this is practicable, including sufficient urinal accommodation; chemical lavatories may be used otherwise;
- a sufficient number of separate water flush-type lavatories for women when this is practicable; again, chemical lavatories may be an alternative;
- the accommodation should be designed and constructed so as to screen the occupants from view and afford protection against the weather;
- the accommodation should be separate from any messroom or rest-room;
- a smooth and impermeable floor;
- effective natural and/or artificial lighting and ventilation;
- at least 30 m from any well;
- constructed for easy maintenance and cleaned out at least daily.

Point to remember:

- Play your part in keeping the facilities clean.

13.3 Washing facilities

Work in the construction industry is often dusty and dirty; it may also involve handling chemicals and other dangerous substances, so that you need to wash your hands and bodies regularly:

- to prevent chemicals contaminating food and so being eaten during snacks or meals, being absorbed through the skin or being carried home;

- to remove dirt and grime, which can also be ingested and cause sickness and disease;
- as a basic hygiene measure.

When construction work involves the maintenance of or alterations to existing buildings, it is often possible to use the facilities which form part of the building. Otherwise, washing facilities should be provided to the following standards:

- one wash-basin for every 15 workers with a sufficient supply of water and an adequate means of removing waste water;
- soap, in the form of cake soap, or liquid or powder soap in a special dispenser, to facilitate quick and proper washing, nail-brushes are needed where poisonous substances are used;
- suitable drying facilities such as paper towels, roller towels (or individual towels for each worker) or electric hand-dryers;
- for facilities likely to be of longer duration, mirrors and shelves at each washing point which will help to keep the place tidy and clean;
- where workers are exposed to skin contamination by chemical substances or by oil or grease, a sufficient number of showers, which should be disinfected daily;
- facilities should be covered to provide weather protection, and effectively ventilated and lit.

Points to remember:

- Always wash your hands before you eat meals.
- Do not take home dirt from the site on you or your clothes.

13.4 Facilities for supplying food and drink, and eating meals

Facilities for supplying food at construction work sites can be particularly

important when sites are located in remote areas. Remoteness, together with inadequate temporary housing which lacks cooking facilities, may give rise to considerable problems for workers in the availability and regularity of hygienically prepared and nutritious meals. The problems of shiftworkers may be even greater.

To meet the need for proper meals, a choice of facilities should be made available:

- facilities to boil water and heat food;
- facilities (including provision of space, shelter, water, heating and rubbish bins) for vendors to sell hot and cold food and drink;
- a canteen supplying cooked meals or serving packed meals, snacks and beverages;
- arrangements with a restaurant or canteen near the work site to supply packaged meals.

13.4.1 The meal area

There should be accommodation with tables and seats, protected from the weather, where one can eat in comfort food brought from home or bought from vendors. It should be situated away from workstations to minimize contact with dirt, dust or dangerous substances.

Point to remember:

- Construction work is physically exhausting, and you need hygienically prepared and nutritious meals at regular times.

13.4.2 Drinking-water

Drinking-water is essential for workers in the construction industry, irrespective of the type of work they do. You lose several litres of water a day while at work and without replacement you gradually dehydrate, the loss is greater in a hot environment.

Arrangements for the supply of safe drinking-water may be:

- individual closed water bottles or containers when no other facilities are available, hung close to the workplace in a shaded place, free from dust and with plenty of air in circulation, cool water helps avoid heat exhaustion. Containers should be cleaned and disinfected at suitable intervals;
- drinking-water containers made of impermeable materials with suitable covers, kept in a cool, protected place. Unglazed pottery containers keep water cool, and they should be kept in dust-free places. The containers should be cleaned regularly by a designated person;
- drinking-water fountains from a public supply with the water outlet shielded in a manner that prevents the lips of the drinker from being placed against it. Drinking-water fountains are more hygienic than taps and drinking vessels;
- water taps from a public supply clearly labelled to distinguish between drinkable and non-drinkable water. It is preferable to use disposable cups or to provide a separate cup for each worker.

Drinking-water should not be placed in sanitary facilities, or in places where it can be contaminated by dust, chemicals or other substances. Whatever the source of water supply for drinking, whether at the mess accommodation or elsewhere on the site, it should be clearly marked as drinking-water in words or with a suitable sign.

Point to remember:

- Drink water only from sources clearly marked as drinking-water.

13.5 Facilities for changing, storing and drying clothes

Secure facilities at the work site for changing from street clothes into work clothes, and for airing and drying the latter, greatly assist workers with their personal hygiene and tidiness and relieve them of anxiety over the security of their possessions.

Changing-rooms are particularly important when workers change from street clothes into protective clothing and when working clothes become wet or dirty. The facilities should include provision for drying wet clothes, whether it be street or working clothing. Separate changing facilities for men and women workers should be provided, at least by adequate screening.

The provision of adequate seats, mirrors and rubbish bins in the changing rooms or close to the lockers will assist workers in paying attention to personal appearance and cleanliness.

13.6 Rest breaks

Construction workers begin work early. They start their day alert and productive but their activity level decreases as the day passes. Fatigue develops gradually before it begins to have marked effects. If you rest before you show signs of being really tired, recovery is much faster. Short breaks taken frequently are much better than infrequent long breaks. Productivity improves with frequent rest breaks.

13.6.1 Frequency of rest breaks

National law may prescribe the length of a working day which includes a period or periods for rest breaks. At least one ten-minute break in the morning and one in the afternoon, in addition to a longer break for lunch, are essential.

Workers are not just idle during rest breaks, but are recovering from fatigue and

preparing for continued productive work. Getting away from a noisy or polluted workplace helps to relax and recover from fatigue, and an area with seating and out of direct sunlight should be set aside for rest breaks.

Point to remember:

- Breaks which are short and taken often are better than long breaks taken infrequently.

13.7 Child-care facilities

Working mothers employed at construction sites often need help with the special problems of caring for their children while they are at work.

13.7.1 Basic provisions

A clean and well-ventilated room, preferably with access to an enclosed space, is the main facility needed. A few items of simple furniture are necessary for the children to sit or lie down, and some toys help. There should be provision for feeding the children with nutritious meals at regular times and, for this, there should also be access to cooking facilities or a canteen.

It is essential for someone to care for the children while their mothers are at work, prepare their meals and feed them regularly. It may be possible for mothers themselves to take turns to look after the children. Mothers, especially nursing mothers, should be able to visit their children during recognized breaks from work.

13.7.2 Watch the children's movements

Each year there are many tragic deaths of children on construction sites. Children should never be allowed to wander into or play on sites. There are excavations to fall into, scaffolding to fall from, hazardous equipment,

loose and dangerous building materials, and chemicals lying about.

Point to remember:

- Child-care facilities pay for themselves by relieving working mothers on site of anxiety over the safety and welfare of their children.

Discussion

If you agree that good work-related welfare facilities improve workers' health and morale and their efficiency, resulting in improved productivity and better work relations, what measures have you seen taken to improve the following types of provision at construction sites?

- lavatories;
- washing facilities;
- eating facilities;
- facilities for changing and storing clothes;
- drinking-water;
- rest breaks;
- child-care facilities.

13.8 First aid

When there is an accident on site and someone is hurt, you can help by:

- calling for help from someone on site trained in first aid, or in cases of severe injury by calling an ambulance;
- preventing others (including yourself) from being injured from the same cause;
- providing life-saving first aid, even if you are not a trained first-aider;
- reporting the accident at once to your supervisor.

13.8.1 Emergency action

There are some situations where you cannot wait for a trained first-aider. Doing

something at once might save an injured person's life. Here are some things you can do:

- check breathing: turn an unconscious person from his or her back to the side to prevent choking on the tongue; be cautious, keeping in mind the possibility of a neck injury;
- provide artificial respiration if breathing has stopped, using the mouth-to-mouth method;
- stop heavy bleeding by direct pressure on the wound and by raising the injured limb (do not try to use a tourniquet);
- cool a burn with water for some ten minutes, never with anything else – extinguish burning clothing by rolling the person on the ground or wrapping them in a blanket;
- flush a burn from corrosives, or contamination of the eyes from any chemical, with water for at least ten minutes;
- treat shock by lying the injured person on his or her side; loosen any tight clothing and cover the person with a blanket to keep him or her warm;
- immobilize a broken limb by bandaging it to two sticks if no splint is available; even tightly rolled newspaper will do.

You should not:

- move an injured person except to remove him or her from danger;
- remove any foreign object embedded in the body;
- give the person anything to drink – you may moisten the lips and tongue if asked to;
- move a broken limb.

Deep cuts and abrasions carry the risk of tetanus (lockjaw) and need to be treated by a doctor. Abrasions, even minor, carry a greater risk of infection than an open wound. After stopping bleeding, clean cuts and abrasions thoroughly with soap and water before covering them with a bandage. Make sure your hands are clean. Always wash your hands with soap after you have finished.

13.8.2 Equipment and training

Construction sites are dangerous places, and first-aid and rescue equipment should always be available. What is needed will depend on the size of the site and the numbers employed, but there should be at least a stocked first-aid box and a stretcher and blanket – the stretcher should be of a type which can be raised and lowered to and from upper floors. On large sites, and always where more than 200 people are employed, there should be a properly equipped first-aid room or hut.

On any construction site of size, at least one person on every shift should have been trained in first aid to a nationally recognized standard.

Point to remember:

- Serious cuts, abrasions and burns must be treated as soon as possible by a doctor or nurse. Limit first aid to a dressing and bandage, if these are necessary.

13.8.3 Moving an injured person

In principle, never move an injured person until a trained first-aider or a doctor can direct you. However, when someone is at risk of further injury and has to be removed to a safe place, lift him or her by using a stretcher or a blanket. If you are alone and must rapidly move an injured person out of danger, then a good way is to drag him or her head first by the clothes.

13.8.4 Investigation

After an accident, leave the site equipment undisturbed as far as it is safe to do so, so that the cause of the accident can be properly investigated. Make sure also that any objects and equipment involved remain

untouched. This is important if proper measures are to be taken to prevent a repetition of the accident.

Discussion

- List the steps you would take if one of your workmates were injured.
- What facilities are there on your site to call for help and to treat injuries?
- How would you give artificial respiration?

13.9 Fire precautions

Fires on construction sites arise from the misuse of compressed gases and highly flammable liquids, from the ignition of waste material, wood shavings and cellular plastic materials, and from the failure to recognize that adhesives and some floor and wall coatings are highly flammable.

Every individual on site should be aware of the fire risk, and should know the precautions to prevent a fire and the action to be taken if fire does break out.

If fire breaks out, get someone to call the fire brigade. Do not continue trying to fight the blaze yourself if large quantities of fumes are being emitted in a closed space. Get out as fast as possible.

Fires are sometimes caused by carelessness in drying wet clothes. Heaters for this purpose, gas, oil or electric, should be mounted on and backed with non-flammable material, and enclosed in a stout wire mesh with effective air space to prevent clothing being placed directly upon them.

If you have to use a blow lamp or torch, or welding or burning equipment in the course of your work, first make sure that there is no fire risk to adjacent materials such as roof timbers. Many fires with disastrous consequences start from this source. Sparks can travel a long distance.

Points to remember:

- Make sure that all lights and heaters are extinguished at the end of each working day.
- Rubbish provides a good starting-point for fire. Keep your work area clean and tidy and do not allow rubbish of any description to accumulate.

Everyone on site should be trained to:

- know of two unobstructed ways off the site if there is a fire or other emergency;
- know how to raise the alarm;
- know where firefighting appliances are kept;
- be able to use the firefighting appliances; and be able to select the correct type of portable fire extinguisher for specific types of fire, as shown in the following table:

Type of portable fire extinguisher	Action	Suitability and dangers
Pressurized water	Cools fuels rapidly – for fires in ordinary combustible building materials	Conducts electricity – not to be used for live electrical equipment or oil fires
Carbon dioxide	Excludes oxygen	Displaces oxygen when used in confined spaces Re-ignition may occur in overheated liquids such as hot bitumen
Dry chemical powder	Interferes with the combustion process	Use in confined areas may lead to a reduction in visibility Non-conductor of electricity and may be used on live electrical equipment Re-ignition may occur in overheated liquids
Foam	Excludes oxygen, limited cooling Forms blanket over flammable liquids	Conducts electricity – not to be used for live electrical components Gives better control over re-ignition than carbon dioxide and dry powder Better suited to extinguish fire in overheated liquids such as bitumen boilers and oil tanks

Point to remember:

- Be aware of at least two unobstructed ways off the site.

Discussion

- Have you been involved in any construction site fires? What was their cause?
- Were they quickly extinguished? If not, what was the reason?

Annex 1

Safety, health and welfare on construction sites: Check-list

The following pages list the main points to consider when you are checking the safety of your site. If a statement cannot be confirmed, for example that all excavations are properly shored, then you should state whether you propose action and what priority you have given to the action. In the "Remarks" section can be entered such comments as the work to be carried out and who is to do it.

Safety organization and management

1. The enterprise has a written safety policy which states the safety and health standards to which the employer should adhere.

	Do you propose action?
	No Yes Priority
	<input type="checkbox"/> <input type="checkbox"/> <input type="checkbox"/>
	Remarks _____

2. Safety and health records are kept at the site.

	Do you propose action?
	No Yes Priority
	<input type="checkbox"/> <input type="checkbox"/> <input type="checkbox"/>
	Remarks _____

3. Training is conducted at all levels, including for managers, supervisors, workers, subcontractors and contract workers.

	Do you propose action?
	No Yes Priority
	<input type="checkbox"/> <input type="checkbox"/> <input type="checkbox"/>
	Remarks _____

4. Safety and health duties are specifically assigned on site.

	Do you propose action?
	No Yes Priority
	<input type="checkbox"/> <input type="checkbox"/> <input type="checkbox"/>
	Remarks _____

5. Tool-box briefings and safety checks are used regularly on site.

	Do you propose action?
	No Yes Priority
	<input type="checkbox"/> <input type="checkbox"/> <input type="checkbox"/>
	Remarks _____

6. There is an active safety committee at the site.

	Do you propose action?
	No Yes Priority
	<input type="checkbox"/> <input type="checkbox"/> <input type="checkbox"/>
	Remarks _____

Site planning, layout and security

7. All workers are aware that the site manager has established a safety policy and what the policy is.

	Do you propose action?
	No Yes Priority
	<input type="checkbox"/> <input type="checkbox"/> <input type="checkbox"/>
	Remarks _____

8. Safety aspects are included appropriately in site planning and layout.

	Do you propose action?
	No Yes Priority
	<input type="checkbox"/> <input type="checkbox"/> <input type="checkbox"/>
	Remarks _____

9. There is a fence at least 2 m high at the boundary of the site.

	Do you propose action?
	No Yes Priority
	<input type="checkbox"/> <input type="checkbox"/> <input type="checkbox"/>
	Remarks _____

10. Where this is not practicable, all excavations and openings are covered or fenced off at the end of the working day.

	Do you propose action?
	No Yes Priority
	<input type="checkbox"/> <input type="checkbox"/> <input type="checkbox"/>
	Remarks _____

11. Ladders are removed from position or their rungs boarded at the end of the working day.

	Do you propose action?
	No Yes Priority
	<input type="checkbox"/> <input type="checkbox"/> <input type="checkbox"/>
	Remarks _____

12. There is a traffic control system on site to control the movement of vehicles in order to avoid danger to pedestrians.

	Do you propose action?
	No Yes Priority
	<input type="checkbox"/> <input type="checkbox"/> <input type="checkbox"/>
	Remarks _____

13. Everyone can reach their place of work safely – that there are safe roadways, walkways, gangways, staircases, ladders and scaffolds.

Do you propose action?
 No Yes Priority

 Remarks _____

14. There is edge protection at all open sides of gangways, floors, staircases and landings where there is a drop of 2 m or more.

Do you propose action?
 No Yes Priority

 Remarks _____

15. Holes and openings are securely fenced off or provided with fixed, clearly marked covers.

Do you propose action?
 No Yes Priority

 Remarks _____

16. There are no projecting nails in timber.

Do you propose action?
 No Yes Priority

 Remarks _____

17. There is adequate artificial lighting at places where persons work after dark and such lighting does not throw deep shadows.

Do you propose action?
 No Yes Priority

 Remarks _____

18. The site is kept tidy and materials are stored safely.

Do you propose action?
 No Yes Priority

 Remarks _____

19. Proper arrangements have been made for collecting and disposing of waste and scrap at frequent intervals.

Do you propose action?
 No Yes Priority

 Remarks _____

Excavations

20. An adequate supply of material such as timber, trench sheets and props with which to shore the sides of excavations has been delivered to the site before the excavation work is to begin.

Do you propose action?
 No Yes Priority

 Remarks _____

21. There are daily inspections of excavations to determine the possibility of a cave-in, and weekly recorded inspections of the shoring.

Do you propose action?
 No Yes Priority

 Remarks _____

22. The sides of excavations are sufficiently shored, or sloped back to 45 degrees.

Do you propose action?
 No Yes Priority

 Remarks _____

23. There is a method of work for putting in shoring which protects the shorer and does not rely on people working within an unsupported trench.

Do you propose action?
 No Yes Priority

 Remarks _____

24. A sufficiently long ladder for safely getting in and out of excavations is available and in use.

Do you propose action?
 No Yes Priority

 Remarks _____

25. There are barriers to stop persons falling into the excavations.

Do you propose action?
 No Yes Priority

 Remarks _____

26. There are no buildings whose stability might be affected by the excavations.

Do you propose action?
 No Yes Priority

 Remarks _____

Annex 1

27. There is no spoil or equipment close to the edge of the excavations likely to cause a collapse at the sides.

Do you propose action?
 No Yes Priority

 Remarks _____

28. Arrangements such as properly secured stop blocks have been made to prevent vehicles driving into the excavations.

Do you propose action?
 No Yes Priority

 Remarks _____

Scaffolding

29. Scaffolds are erected under the supervision of someone competent in scaffold erection.

Do you propose action?
 No Yes Priority

 Remarks _____

30. There is proper access to all parts of the scaffold platforms.

Do you propose action?
 No Yes Priority

 Remarks _____

31. All the uprights of the scaffold are mounted on proper base plates and timber sole plates if necessary, or prevented in some other way from slipping or sinking.

Do you propose action?
 No Yes Priority

 Remarks _____

32. No parts of the scaffold, including ties, have been removed after it was erected.

Do you propose action?
 No Yes Priority

 Remarks _____

33. The scaffold is secured to the building in enough places to prevent scaffold collapse.

Do you propose action?
 No Yes Priority

 Remarks _____

34. The uprights of the scaffold are vertical and securely braced to prevent swaying or displacement.

Do you propose action?
 No Yes Priority

 Remarks _____

35. The working platforms are close boarded with scaffold boards or planks of proper grade timber without obvious defects such as knots.

Do you propose action?
 No Yes Priority

 Remarks _____

36. There are effective barriers and warning notices to stop people using an incomplete scaffold, e.g. one that is not fully boarded.

Do you propose action?
 No Yes Priority

 Remarks _____

37. The boards are arranged so as to avoid the risk of tripping.

Do you propose action?
 No Yes Priority

 Remarks _____

38. Guard-rails and toe boards are erected to a safe height at the open sides and ends of scaffold platforms from which there is a drop of 2 m or more.

Do you propose action?
 No Yes Priority

 Remarks _____

39. Materials are evenly distributed over scaffolds designed to carry materials, and they are not overloaded.

Do you propose action?
 No Yes Priority

 Remarks _____

40. Unsecured tower scaffolds have a safe height-to-base area ratio of not more than 3 to 1.

Do you propose action?
 No Yes Priority

 Remarks _____

Safety, health and welfare on construction sites

41. The wheels of mobile tower scaffolds are properly locked and secured.

Do you propose action?
 No Yes Priority

Remarks _____

42. Access ladders for tower scaffolds are fitted internally and not externally.

Do you propose action?
 No Yes Priority

Remarks _____

43. Workers on suspended scaffolds are using lifelines anchored overhead to the building and not to the scaffold.

Do you propose action?
 No Yes Priority

Remarks _____

44. Scaffolds are inspected by a competent person at least once a week, and always after windy and bad weather.

Do you propose action?
 No Yes Priority

Remarks _____

45. The results of scaffold inspections are recorded and signed by the person who carried out the inspections.

Do you propose action?
 No Yes Priority

Remarks _____

Ladders

46. Ladders are not being used for jobs which require a scaffold.

Do you propose action?
 No Yes Priority

Remarks _____

47. Metal ladders are not being used near overhead power lines.

Do you propose action?
 No Yes Priority

Remarks _____

48. The ladders that are in use are in good condition.

Do you propose action?
 No Yes Priority

Remarks _____

49. Ladders are secured at or near the top whenever practicable even if only used for a short time.

Do you propose action?
 No Yes Priority

Remarks _____

50. Where ladders cannot be secured at the top for technical reasons, they are secured near the bottom or footed.

Do you propose action?
 No Yes Priority

Remarks _____

51. Ladders rise at least 1 m above their landing places or the highest rung used. If this is not practicable, there are adequate handholds.

Do you propose action?
 No Yes Priority

Remarks _____

52. Ladders are inspected regularly for signs of damage or corrosion.

Do you propose action?
 No Yes Priority

Remarks _____

53. All ladders are marked for identification.

Do you propose action?
 No Yes Priority

Remarks _____

Roof work

54. Except where roof battens provide adequate handholds and footholds, crawling boards or crawling ladders are used to work on roof slopes of more than 10 degrees.

Do you propose action?
 No Yes Priority

Remarks _____

Annex 1

55. Sufficient guard-rails and toe boards or other forms of edge protection are provided to prevent a worker or materials falling more than 2 m from sloping or flat roofs.

Do you propose action?
 No Yes Priority

Remarks _____

56. There are crawling boards for work above fragile material such as asbestos cement sheets or glass.

Do you propose action?
 No Yes Priority

Remarks _____

57. Precautions are taken during sheeting operations to stop persons falling from the edge of the sheets.

Do you propose action?
 No Yes Priority

Remarks _____

58. Warning notices are displayed at all approaches to fragile roofs.

Do you propose action?
 No Yes Priority

Remarks _____

59. There are guard-rails or covers at places where it is necessary to pass close to fragile material or to roof lights.

Do you propose action?
 No Yes Priority

Remarks _____

60. Precautions are taken to stop debris falling onto others working under the roof work.

Do you propose action?
 No Yes Priority

Remarks _____

Steel erection

61. Steel erectors work from temporary access platforms wherever possible.

Do you propose action?
 No Yes Priority

Remarks _____

62. Where temporary access platforms are not in use, steel erectors wear safety harnesses and lifelines attached to secure anchorage points.

Do you propose action?
 No Yes Priority

Remarks _____

63. There are suitable anchorage points for the attachment of safety harnesses and lifelines.

Do you propose action?
 No Yes Priority

Remarks _____

64. A tightly planked temporary floor is installed at heights above 10 metres or two storeys when steel erection is in progress.

Do you propose action?
 No Yes Priority

Remarks _____

65. A safety net is used where the distance of fall exceeds two storeys.

Do you propose action?
 No Yes Priority

Remarks _____

66. Safety lines are used to prevent the dangerous swing of steelwork when it is being raised or lowered by crane.

Do you propose action?
 No Yes Priority

Remarks _____

Work over water

67. A manned safety boat is in position.

Do you propose action?
 No Yes Priority

Remarks _____

68. There are a sufficient number of lifebuoys and lines conveniently to hand.

Do you propose action?
 No Yes Priority

Remarks _____

Demolition

69. The construction characteristics of the building being demolished have been obtained before demolition begins.
- Do you propose action?
 No Yes Priority

 Remarks _____
70. Demolition operations are being directly supervised by a competent person who has established a demolition plan.
- Do you propose action?
 No Yes Priority

 Remarks _____
71. A safe working platform has been provided from which demolition workers are operating, and not directly from the building.
- Do you propose action?
 No Yes Priority

 Remarks _____
72. Debris is not allowed to collect on floors to create a danger of collapse.
- Do you propose action?
 No Yes Priority

 Remarks _____

Confined spaces

73. The internal atmosphere of a confined space is tested before work begins, to assure an adequate level of oxygen in the air and freedom from toxic gases.
- Do you propose action?
 No Yes Priority

 Remarks _____
74. Self-contained breathing apparatus is used and a safety harness and a lifeline worn by those working in a confined space.
- Do you propose action?
 No Yes Priority

 Remarks _____

75. Any confined space is adequately ventilated with fresh air before anyone enters.
- Do you propose action?
 No Yes Priority

 Remarks _____
76. It is not possible for vehicle exhaust fumes to collect in a manhole in which work is being carried on.
- Do you propose action?
 No Yes Priority

 Remarks _____
77. Those working in a confined space are in direct communication with a worker outside the space who is equipped with reserve apparatus and trained in its use.
- Do you propose action?
 No Yes Priority

 Remarks _____

Piling

78. Underground services are located and made safe.
- Do you propose action?
 No Yes Priority

 Remarks _____
79. There is a firm level base for the crane, or crane mats are provided.
- Do you propose action?
 No Yes Priority

 Remarks _____
80. Proper personal protective equipment is used where necessary.
- Do you propose action?
 No Yes Priority

 Remarks _____

Transport

81. All site vehicles are in good repair.

Do you propose action?
 No Yes Priority

Remarks _____

82. Roll-over protection is provided for vehicles that are liable to overturn.

Do you propose action?
 No Yes Priority

Remarks _____

83. The steering, hand-brake and foot-brake of every vehicle in use works properly.

Do you propose action?
 No Yes Priority

Remarks _____

84. Only workers who have received proper training drive site vehicles and hold recognized driving licences if they drive those vehicles on public roads.

Do you propose action?
 No Yes Priority

Remarks _____

85. Drivers are trained to secure properly the loads of all site vehicles.

Do you propose action?
 No Yes Priority

Remarks _____

86. Those working with tipping lorries are trained not to go beneath the raised body.

Do you propose action?
 No Yes Priority

Remarks _____

87. Only authorized passengers are allowed to ride on site vehicles, and then in safe positions.

Do you propose action?
 No Yes Priority

Remarks _____

88. Vehicles are equipped with a reversing signal where appropriate.

Do you propose action?
 No Yes Priority

Remarks _____

89. When vehicles reverse with a load, the driver should be directed by a second trained worker or banksman.

Do you propose action?
 No Yes Priority

Remarks _____

Cranes

90. Every crane (or excavator used as a crane) is inspected daily by the driver prior to use.

Do you propose action?
 No Yes Priority

Remarks _____

91. Every crane is inspected weekly by a competent person, and a record is kept.

Do you propose action?
 No Yes Priority

Remarks _____

92. Every crane is thoroughly examined at regular intervals of not more than 12 months by a competent person, and a record is kept.

Do you propose action?
 No Yes Priority

Remarks _____

93. There is a test certificate for each crane.

Do you propose action?
 No Yes Priority

Remarks _____

94. Every crane is regularly maintained.

Do you propose action?
 No Yes Priority

Remarks _____

Safety, health and welfare on construction sites

95. The crane operator is trained and competent, and is over the age of 18.

Do you propose action?
 No Yes Priority

 Remarks _____

96. The rated load capacities for varying radii of the jib, operating speeds and instructions are displayed and are visible to the operator.

Do you propose action?
 No Yes Priority

 Remarks _____

97. Crane cabins are safe and well designed, with safe means of access to them, and crane controls are clearly marked.

Do you propose action?
 No Yes Priority

 Remarks _____

98. Crane operators and signallers/banksmen are trained in the use of hand signals, and illustrations are displayed on site.

Do you propose action?
 No Yes Priority

 Remarks _____

99. Operators and banksmen find out the weight of a load which they do not know before lifting it. Banksmen have been trained in the attachment of loads.

Do you propose action?
 No Yes Priority

 Remarks _____

100. Every crane of more than 1 tonne capacity has an efficient automatic safe load indicator which is inspected weekly.

Do you propose action?
 No Yes Priority

 Remarks _____

101. Every crane is operating on a hard and level base and crane outriggers are being used when required.

Do you propose action?
 No Yes Priority

 Remarks _____

102. There is a safe means of access to all parts of the crane to which it is necessary to go for operation or maintenance.

Do you propose action?
 No Yes Priority

 Remarks _____

Goods or platform hoists

103. Every goods or platform hoist, including the hoisting rope, is inspected weekly by a competent person and a record kept.

Do you propose action?
 No Yes Priority

 Remarks _____

104. Every hoist is thoroughly examined by a competent person every six months and a record kept.

Do you propose action?
 No Yes Priority

 Remarks _____

105. Every hoist is surrounded by a substantial fence to a height of 2 m to prevent workers being struck by the hoist platform or falling down the hoistway.

Do you propose action?
 No Yes Priority

 Remarks _____

106. There are gates at all landings and points of access to the hoist platform.

Do you propose action?
 No Yes Priority

 Remarks _____

107. The gates are kept shut when the platform is not at that landing.

Do you propose action?
 No Yes Priority

 Remarks _____

108. There is a load-rating plate on the hoist platform, giving its safe working load.

Do you propose action?
 No Yes Priority

Remarks _____

109. There is a notice prohibiting workers from riding on the platforms of goods hoists.

Do you propose action?
 No Yes Priority

Remarks _____

110. The operator is trained and competent, and is aged over 18.

Do you propose action?
 No Yes Priority

Remarks _____

111. There is overhead protection against falling material over the operator's position.

Do you propose action?
 No Yes Priority

Remarks _____

112. Controls are arranged so that the hoist can be operated from one position only.

Do you propose action?
 No Yes Priority

Remarks _____

113. The platform has brakes or devices which will hold it and the load in position if the hoisting rope or mechanism fails.

Do you propose action?
 No Yes Priority

Remarks _____

114. There are at least three full turns of rope on the winch winding down when the platform is in its lowest position.

Do you propose action?
 No Yes Priority

Remarks _____

115. A proper signalling system is in use.

Do you propose action?
 No Yes Priority

Remarks _____

Gin or pulley wheels

116. The supporting beam is securely attached to two uprights.

Do you propose action?
 No Yes Priority

Remarks _____

117. The lifting ropes are in good condition.

Do you propose action?
 No Yes Priority

Remarks _____

118. The hooks are properly designed and constructed.

Do you propose action?
 No Yes Priority

Remarks _____

Ergonomics

119. Mechanical power is used to replace heavy work where possible.

Do you propose action?
 No Yes Priority

Remarks _____

120. Effective rest periods are included in the workday.

Do you propose action?
 No Yes Priority

Remarks _____

Hand tools

121. Alternative methods are available to reduce strain in strenuous tasks.

Do you propose action?
 No Yes Priority

Remarks _____

122. Work is done in a sitting position whenever possible.

Do you propose action?
 No Yes Priority

Remarks _____

123. Materials, tools and controls are kept within easy reach of the worker.

Do you propose action?
 No Yes Priority

Remarks _____

124. Machines with cabins are checked and maintained regularly.

Do you propose action?
 No Yes Priority

Remarks _____

Machinery

125. All dangerous parts such as exposed gears, chain drives and projecting shafts are adequately guarded.

Do you propose action?
 No Yes Priority

Remarks _____

126. All guards are secured and in good repair.

Do you propose action?
 No Yes Priority

Remarks _____

127. Hand tools are regularly inspected for safe condition.

Do you propose action?
 No Yes Priority

Remarks _____

128. Tool handles are free from splits and cracks.

Do you propose action?
 No Yes Priority

Remarks _____

129. Tool handles are firmly fixed to the heads of all tools.

Do you propose action?
 No Yes Priority

Remarks _____

130. Hammers, chisels and other impact tools do not have mushroomed heads.

Do you propose action?
 No Yes Priority

Remarks _____

131. The edges or teeth of cutting tools are kept sharp.

Do you propose action?
 No Yes Priority

Remarks _____

Cartridge-operated tools (or bolt guns)

132. The operators of bolt guns are properly trained so that they are able to deal with misfires.

Do you propose action?
 No Yes Priority

Remarks _____

133. The operators are informed and trained on the basis of the manufacturers' instructions.

Do you propose action?
 No Yes Priority

Remarks _____

Annex 1

134. Bolt guns and cartridges not in use are unloaded and kept in a secured place.

Do you propose action?
 No Yes Priority

Remarks _____

135. Bolt guns are regularly cleaned and inspected each day before use.

Do you propose action?
 No Yes Priority

Remarks _____

136. Safety helmets, safety goggles and safety shoes are worn by the operator and others within the vicinity.

Do you propose action?
 No Yes Priority

Remarks _____

137. Ear protection is used by the operator, particularly when working in confined spaces.

Do you propose action?
 No Yes Priority

Remarks _____

Power-driven machinery

138. Circular saw blades are adequately guarded.

Do you propose action?
 No Yes Priority

Remarks _____

139. The fence is locked securely in position before using a circular saw.

Do you propose action?
 No Yes Priority

Remarks _____

140. Push-sticks are used when hand feeding material into a circular saw and when removing cut pieces.

Do you propose action?
 No Yes Priority

Remarks _____

141. Compressed air tools are used with caution and are never directed at people.

Do you propose action?
 No Yes Priority

Remarks _____

Electrical equipment

142. Electrical equipment, including portable electric tools, is supplied from a reduced voltage supply, or special measures are taken to protect equipment and cables from mechanical damage and wet conditions.

Do you propose action?
 No Yes Priority

Remarks _____

143. Electrical equipment, including wires and cables, is inspected for signs of damage or interference daily or before use.

Do you propose action?
 No Yes Priority

Remarks _____

144. All connections to the power supply are made by proper connectors or plugs.

Do you propose action?
 No Yes Priority

Remarks _____

145. All connections to plugs are properly made so that the cable grip holds the cable firmly and prevents the ground or earth wire from being pulled out.

Do you propose action?
 No Yes Priority

Remarks _____

146. All electrical equipment is grounded or earthed.

Do you propose action?
 No Yes Priority

Remarks _____

147. Where anything may touch overhead electric lines or cause arcing (such as crane jibs, tipper lorries or scaffolding), the electricity supply is turned off whenever possible.

Do you propose action?
 No Yes Priority

 Remarks _____

148. Where the supply to overhead power lines has not been turned off, ensure that other precautions such as the erection of "goalposts" have been taken to prevent contact with the lines.

Do you propose action?
 No Yes Priority

 Remarks _____

149. The pressure and route of underground cables has been marked and precautions taken to avoid contact with them.

Do you propose action?
 No Yes Priority

 Remarks _____

Welding and cutting

150. Precautions are taken to protect welders, as well as others working near the welding process.

Do you propose action?
 No Yes Priority

 Remarks _____

151. Cylinders are stored properly and separately from one another.

Do you propose action?
 No Yes Priority

 Remarks _____

152. Precautions are taken to prevent an accumulation of toxic gases and fumes.

Do you propose action?
 No Yes Priority

 Remarks _____

Compressed gas (LPG, acetylene)

153. Cylinders are properly stored.

Do you propose action?
 No Yes Priority

 Remarks _____

154. The valves of all cylinders are closed when the cylinder is not in use.

Do you propose action?
 No Yes Priority

 Remarks _____

155. No LPG cylinders are located inside huts.

Do you propose action?
 No Yes Priority

 Remarks _____

156. There are proper waste receptacles for combustible material and all waste is removed regularly from the site.

Do you propose action?
 No Yes Priority

 Remarks _____

Hazardous substances

157. All harmful materials such as asbestos and lead have been identified and suitable precautions taken.

Do you propose action?
 No Yes Priority

 Remarks _____

158. All containers of hazardous chemicals in use on site are properly labelled.

Do you propose action?
 No Yes Priority

 Remarks _____

159. Chemical safety data sheets are available for obtaining information about hazardous chemicals in use.

Do you propose action?
 No Yes Priority

 Remarks _____

Annex 1

160. Advice given by chemical safety data sheets is followed.

Do you propose action?
 No Yes Priority

Remarks _____

167. Hearing protection is properly fitted and maintained in a clean and sanitary condition.

Do you propose action?
 No Yes Priority

Remarks _____

161. Workers are aware of the hazards of the substances they are using and have been informed of the precautions to be taken by them, in particular when using cement.

Do you propose action?
 No Yes Priority

Remarks _____

Lighting; exposure to heat and cold

168. All parts of the work site are properly lit by natural or artificial light whenever work is going on.

Do you propose action?
 No Yes Priority

Remarks _____

162. Workers have been trained in the handling and use of hazardous chemicals.

Do you propose action?
 No Yes Priority

Remarks _____

169. Adequate welfare facilities are provided in hot climates and suitable working-time arrangements are made.

Do you propose action?
 No Yes Priority

Remarks _____

Noise and vibration

163. All pneumatic drills/concrete breakers are fitted with silencer muffs.

Do you propose action?
 No Yes Priority

Remarks _____

170. Workers are adequately protected when cold weather is experienced.

Do you propose action?
 No Yes Priority

Remarks _____

164. Exhaust systems of other machinery are fitted with silencers.

Do you propose action?
 No Yes Priority

Remarks _____

Personal protective equipment

171. Personal protective clothing and equipment is provided to protect the head, eyes, hands and feet.

Do you propose action?
 No Yes Priority

Remarks _____

165. Machinery covers are kept closed while the machinery is in use.

Do you propose action?
 No Yes Priority

Remarks _____

172. Respiratory protective equipment is required, is available and workers are trained in its use.

Do you propose action?
 No Yes Priority

Remarks _____

166. Hearing protection is worn when working at or near noisy processes.

Do you propose action?
 No Yes Priority

Remarks _____

Safety, health and welfare on construction sites

173. The workers wear and use the protective clothing and equipment.

Do you propose action?

No	Yes	Priority
<input type="checkbox"/>	<input type="checkbox"/>	<input type="checkbox"/>

Remarks _____

180. All workers are trained about action to be taken in emergency first-aid situations following an accident.

Do you propose action?

No	Yes	Priority
<input type="checkbox"/>	<input type="checkbox"/>	<input type="checkbox"/>

Remarks _____

Welfare facilities

174. There are sufficient and suitable lavatories, if practicable water closets, including urinals.

Do you propose action?

No	Yes	Priority
<input type="checkbox"/>	<input type="checkbox"/>	<input type="checkbox"/>

Remarks _____

Fire precautions

181. There are the right number and type of fire extinguishers on the site.

Do you propose action?

No	Yes	Priority
<input type="checkbox"/>	<input type="checkbox"/>	<input type="checkbox"/>

Remarks _____

175. There are sufficient and suitable washing facilities, including soap and means of drying.

Do you propose action?

No	Yes	Priority
<input type="checkbox"/>	<input type="checkbox"/>	<input type="checkbox"/>

Remarks _____

182. There are adequate escape routes in case of fire.

Do you propose action?

No	Yes	Priority
<input type="checkbox"/>	<input type="checkbox"/>	<input type="checkbox"/>

Remarks _____

176. There are separate lavatories and washing facilities for men and women workers.

Do you propose action?

No	Yes	Priority
<input type="checkbox"/>	<input type="checkbox"/>	<input type="checkbox"/>

Remarks _____

183. The amount of flammable liquids in actual use does not exceed a day's supply.

Do you propose action?

No	Yes	Priority
<input type="checkbox"/>	<input type="checkbox"/>	<input type="checkbox"/>

Remarks _____

177. There is sufficient and suitable accommodation for the storage and drying of both "street" and work clothing.

Do you propose action?

No	Yes	Priority
<input type="checkbox"/>	<input type="checkbox"/>	<input type="checkbox"/>

Remarks _____

184. Flammable liquids are kept in safe containers held in a proper store area.

Do you propose action?

No	Yes	Priority
<input type="checkbox"/>	<input type="checkbox"/>	<input type="checkbox"/>

Remarks _____

178. There are sufficient and suitable facilities for preparing and eating food.

Do you propose action?

No	Yes	Priority
<input type="checkbox"/>	<input type="checkbox"/>	<input type="checkbox"/>

Remarks _____

185. Smoking is prohibited while using flammable liquids.

Do you propose action?

No	Yes	Priority
<input type="checkbox"/>	<input type="checkbox"/>	<input type="checkbox"/>

Remarks _____

179. There are sufficient and suitable provisions made for first aid and medical treatment.

Do you propose action?

No	Yes	Priority
<input type="checkbox"/>	<input type="checkbox"/>	<input type="checkbox"/>

Remarks _____

Annex 2

The Safety and Health in Construction Convention, 1988 (No. 167)

(extracts)

PART I. SCOPE AND DEFINITIONS

Article 1

1. This Convention applies to all construction activities, namely building, civil engineering, and erection and dismantling work, including any process, operation or transport on a construction site, from the preparation of the site to the completion of the project

2. A Member ratifying this Convention may, after consultation with the most representative organizations of employers and workers concerned, where they exist, exclude from the application of the Convention, or certain provisions thereof, particular branches of economic activity or particular undertakings in respect of which special problems of a substantial nature arise, on condition that a safe and healthy working environment is maintained.

3. This Convention also applies to such self-employed persons as may be specified by national laws or regulations.

Article 2

For the purpose of this Convention:

- (a) The term “construction” covers:
- (i) building, including excavation and the construction, structural alteration, renovation, repair, maintenance (including cleaning and painting) and demolition of all types of buildings or structures;
 - (ii) civil engineering, including excavation and the construction, structural alteration, repair, maintenance and demolition of, for example, airports, docks, harbours, inland waterways, dams, river and avalanche and sea defence works, roads and highways, railways, bridges, tunnels, viaducts and works related to the provision of services such as communications, drainage, sewerage, water and energy supplies;
 - (iii) the erection and dismantling of prefabricated buildings and structures, as well as the manufacturing of prefabricated elements on the construction site;

- (b) the term “construction site” means any site at which any of the processes or operations described in subparagraph (a) above are carried on;
- (c) the term “workplace” means all places where workers need to be or to go by reason of their work and which are under the control of an employer as defined in subparagraph (e) below;
- (d) the term “worker” means any person engaged in construction;
- (e) the term “employer” means:
 - (i) any physical or legal person who employs one or more workers on a construction site; and
 - (ii) as the context requires, the principal contractor, the contractor or the subcontractor;
- (f) the term “competent person” means a person possessing adequate qualifications, such as suitable training and sufficient knowledge, experience and skill for the safe performance of the specific work. The competent authorities may define appropriate criteria for the designation of such persons and may determine the duties to be assigned to them;
- (g) the term “scaffold” means any temporary structure, fixed, suspended or mobile, and its supporting components which is used for supporting workers and materials or to gain access to any such structure, and which is not a lifting appliance as defined in subparagraph (h) below;
- (h) the term “lifting appliance” means any stationary or mobile appliance used for raising or lowering persons or loads;
- (i) the term “lifting gear” means any gear or tackle by means of which a load can be attached to a lifting appliance but which does not form an integral part of the appliance or load.

PART II. GENERAL PROVISIONS

Article 3

The most representative organizations of employers and workers concerned shall be consulted on the measures to be taken to give effect to the provisions of this Convention.

Article 4

Each Member which ratifies this Convention undertakes that it will, on the basis of an assessment of the safety and health hazards involved, adopt and maintain in force laws or regulations which ensure the application of the provisions of the Convention.

Article 5

1. The laws and regulations adopted in pursuance of Article 4 above may provide for their practical application through technical standards or codes of practice, or by other appropriate methods consistent with national conditions and practice

2. In giving effect to Article 4 above and to paragraph 1 of this Article, each Member shall have due regard to the relevant standards adopted by recognized international organizations in the field of standardization.

Article 6

Measures shall be taken to ensure that there is cooperation between employers and workers, in accordance with arrangements to be defined by national laws or regulations, in order to promote safety and health at construction sites.

Article 7

National laws or regulations shall require that employers and self-employed persons have a duty to comply with the prescribed safety and health measures at the workplace.

Article 8

1. Whenever two or more employers undertake activities simultaneously at one construction site –

- (a) the principal contractor, or other person or body with actual control over or primary responsibility for overall construction site activities, shall be responsible for coordinating the prescribed safety and health measures and, in so far as is compatible with national laws and regulations, for ensuring compliance with such measures;
- (b) in so far as is compatible with national laws and regulations, where the principal contractor, or other person or body with actual control over or primary responsibility for overall construction site activities, is not present at the site, he shall nominate a competent person or body at the site with the authority and means necessary to ensure on his behalf coordination and compliance with the measures, as foreseen in subparagraph (a) above;

- (c) each employer shall remain responsible for the application of the prescribed measures in respect of the workers placed under his authority.

2. Whenever employers or self-employed persons undertake activities simultaneously at one construction site they shall have the duty to cooperate in the application of the prescribed safety and health measures, as may be specified by national laws or regulations.

Article 9

Those concerned with the design and planning of a construction project shall take into account the safety and health of the construction workers in accordance with national laws, regulations and practice.

Article 10

National laws or regulations shall provide that workers shall have the right and the duty at any workplace to participate in ensuring safe working conditions to the extent of their control over the equipment and methods of work and to express views on the working procedures adopted as they may affect safety and health.

Article 11

National laws or regulations shall provide that workers shall have the duty to –

- (a) cooperate as closely as possible with their employer in the application of the prescribed safety and health measures;
- (b) take reasonable care for their own safety and health and that of other persons who may be affected by their acts or omissions at work;
- (c) use facilities placed at their disposal and not misuse anything provided for their own protection or the protection of others;
- (d) report forthwith to their immediate supervisor, and to the workers' safety representative where one exists, any situation which they believe could present a risk, and which they cannot properly deal with themselves;
- (e) comply with the prescribed safety and health measures.

Article 12

1. National laws or regulations shall provide that a worker shall have the right to remove himself from danger when he has good reason to believe that there is an imminent and serious danger to his safety or health, and the duty so to inform his supervisor immediately.

2. Where there is an imminent danger to the safety of workers the employer shall take immediate steps to stop the operation and evacuate workers as appropriate.

PART III. PREVENTIVE AND PROTECTIVE MEASURES

Article 13

Safety of workplaces

1. All appropriate precautions shall be taken to ensure that all workplaces are safe and without risk of injury to the safety and health of workers.

2. Safe means of access to and egress from all workplaces shall be provided and maintained, and indicated where appropriate.

3. All appropriate precautions shall be taken to protect persons present at or in the vicinity of a construction site from all risks which may arise from such site.

Article 14

Scaffolds and ladders

1. Where work cannot safely be done on or from the ground or from part of a building or other permanent structure, a safe and suitable scaffold shall be provided and maintained, or other equally safe and suitable provision shall be made.

2. In the absence of alternative safe means of access to elevated working places, suitable and sound ladders shall be provided. They shall be properly secured against inadvertent movement.

3. All scaffolds and ladders shall be constructed and used in accordance with national laws and regulations.

4. Scaffolds shall be inspected by a competent person in such cases and at such times as shall be prescribed by national laws or regulations.

Article 15

Lifting appliances and gear

1. Every lifting appliance and item of lifting gear, including their constituent elements, attachments, anchorages and supports, shall –

- (a) be of good design and construction, sound material and adequate strength for the purpose for which they are used;
- (b) be properly installed and used;
- (c) be maintained in good working order;

- (d) be examined and tested by a competent person at such times and in such cases as shall be prescribed by national laws or regulations: the results of these examinations and tests shall be recorded;
- (e) be operated by workers who have received appropriate training in accordance with national laws and regulations.

2. No person shall be raised, lowered or carried by a lifting appliance unless it is constructed, installed and used for that purpose in accordance with national laws and regulations, except in an emergency situation in which serious personal injury or fatality may occur, and for which the lifting appliance can be safely used.

Article 16

Transport, earth-moving and materials-handling equipment

1. All vehicles and earth-moving or materials-handling equipment shall –

- (a) be of good design and construction taking into account as far as possible ergonomic principles;
- (b) be maintained in good working order;
- (c) be properly used;
- (d) be operated by workers who have received appropriate training in accordance with national laws and regulations.

2. On all construction sites on which vehicles, earth-moving or materials-handling equipment are used –

- (a) safe and suitable access ways shall be provided for them; and
- (b) traffic shall be so organized and controlled as to secure their safe operation.

Article 17

Plant, machinery, equipment and hand tools

1. Plant, machinery and equipment, including hand tools, both manual and power driven, shall –

- (a) be of good design and construction, taking into account as far as possible ergonomic principles;
- (b) be maintained in good working order;
- (c) be used only for work for which they have been designed unless a use outside the initial design purposes has been assessed by a competent person who has concluded that such use is safe;
- (d) be operated by workers who have received appropriate training.

2. Adequate instructions for safe use shall be provided where appropriate by the manufacturer or the employer, in a form understood by the users.

Safety, health and welfare on construction sites

3. Pressure plant and equipment shall be examined and tested by a competent person in cases and at times prescribed by national laws or regulations.

Article 18

Work at heights including roofwork

1. Where necessary to guard against danger, or where the height of a structure or its slope exceeds that prescribed by national laws or regulations, preventive measures shall be taken against the fall of workers and tools or other objects or materials.

2. Where workers are required to work on or near roofs or other places covered with fragile material, through which they are liable to fall, preventive measures shall be taken against their inadvertently stepping on or falling through the fragile material.

Article 19

Excavations, shafts, earthworks, underground works and tunnels

Adequate precautions shall be taken in any excavation, shaft, earthworks, underground works or tunnel –

- (a) by suitable shoring or otherwise to guard against danger to workers from a fall or dislodgement of earth, rock or other material;
- (b) to guard against dangers arising from the fall of persons, materials or objects or the inrush of water into the excavation, shaft, earthworks, underground works or tunnel;
- (c) to secure adequate ventilation at every workplace so as to maintain an atmosphere fit for respiration and to limit any fumes, gases, vapours, dust or other impurities to levels which are not dangerous or injurious to health and are within limits laid down by national laws or regulations;
- (d) to enable the workers to reach safety in the event of fire, or an inrush of water or material;
- (e) to avoid risk to workers arising from possible underground dangers such as the circulation of fluids or the presence of pockets of gas, by undertaking appropriate investigations to locate them.

Article 20

Cofferdams and caissons

1. Every cofferdam and caisson shall be –
- (a) of good construction and suitable and sound material and of adequate strength,
 - (b) provided with adequate means for workers to reach safety in the event of an inrush of water or material.

2. The construction, positioning, modification or dismantling of a cofferdam or caisson shall take place only under the immediate supervision of a competent person.

3. Every cofferdam and caisson shall be inspected by a competent person at prescribed intervals.

Article 21

Work in compressed air

1. Work in compressed air shall be carried out only in accordance with measures prescribed by national laws or regulations.

2. Work in compressed air shall be carried out only by workers whose physical aptitude for such work has been established by a medical examination and when a competent person is present to supervise the conduct of the operations.

Article 22

Structural frames and formwork

1. The erection of structural frames and components, formwork, falsework and shoring shall be carried out only under the supervision of a competent person.

2. Adequate precautions shall be taken to guard against danger to workers arising from any temporary state of weakness or instability of a structure.

3. Formwork, falsework and shoring shall be so designed, constructed and maintained that it will safely support all loads that may be imposed on it.

Article 23

Work over water

Where work is done over or in close proximity to water there shall be adequate provision for –

- (a) preventing workers from falling into water;
- (b) the rescue of workers in danger of drowning;
- (c) safe and sufficient transport.

Article 24

Demolition

When the demolition of any building or structure might present danger to workers or to the public –

- (a) appropriate precautions, methods and procedures shall be adopted, including those for the disposal of waste or residues, in accordance with national laws or regulations;
- (b) the work shall be planned and undertaken only under the supervision of a competent person.

Article 25

Lighting

Adequate and suitable lighting, including portable lighting where appropriate, shall be provided at every workplace and any other place on the construction site where a worker may have to pass.

Article 26

Electricity

1. All electrical equipment and installations shall be constructed, installed and maintained by a competent person, and so used as to guard against danger.

2. Before construction is commenced and during the progress thereof adequate steps shall be taken to ascertain the presence of and to guard against danger to workers from any live electrical cable or apparatus which is under, over or on the site.

3. The laying and maintenance of electrical cables and apparatus on construction sites shall be governed by the technical rules and standards applied at the national level.

Article 27

Explosives

Explosives shall not be stored, transported, handled or used except –

- (a) under conditions prescribed by national laws or regulations; and
- (b) by a competent person, who shall take such steps as are necessary to ensure that workers and other persons are not exposed to risk of injury.

Article 28

Health hazards

1. Where a worker is liable to be exposed to any chemical, physical or biological hazard to such an extent as is liable to be dangerous to health, appropriate preventive measures shall be taken against such exposure

2. The preventive measures referred to in paragraph 1 above shall comprise –

- (a) the replacement of hazardous substances by harmless or less hazardous substances wherever possible; or
- (b) technical measures applied to the plant, machinery, equipment or process; or
- (c) where it is not possible to comply with subparagraphs (a) or (b) above, other effective

measures, including the use of personal protective equipment and protective clothing.

3. Where workers are required to enter any area in which a toxic or harmful substance may be present, or in which there may be an oxygen deficiency, or a flammable atmosphere, adequate measures shall be taken to guard against danger.

4. Waste shall not be destroyed or otherwise disposed of on a construction site in a manner which is liable to be injurious to health.

Article 29

Fire precautions

1. The employer shall take all appropriate measures to –

- (a) avoid the risk of fire;
- (b) combat quickly and efficiently any outbreak of fire;
- (c) bring about a quick and safe evacuation of persons.

2. Sufficient and suitable storage shall be provided for flammable liquids, solids and gases.

Article 30

Personal protective equipment and protective clothing

1. Where adequate protection against risk of accident or injury to health, including exposure to adverse conditions, cannot be ensured by other means, suitable personal protective equipment and protective clothing, having regard to the type of work and risks, shall be provided and maintained by the employer, without cost to the workers, as may be prescribed by national laws or regulations.

2. The employer shall provide the workers with the appropriate means to enable them to use the individual protective equipment, and shall ensure its proper use.

3. Protective equipment and protective clothing shall comply with standards set by the competent authority taking into account as far as possible ergonomic principles.

4. Workers shall be required to make proper use of and to take good care of the personal protective equipment and protective clothing provided for their use.

Article 31

First aid

The employer shall be responsible for ensuring that first aid, including trained personnel, is available at all times. Arrangements shall be made for ensuring the

removal for medical attention of workers who have suffered an accident or sudden illness.

Article 32

Welfare

1. At or within reasonable access of every construction site an adequate supply of wholesome drinking water shall be provided.

2. At or within reasonable access of every construction site, the following facilities shall, depending on the number of workers and the duration of the work, be provided and maintained –

- (a) sanitary and washing facilities;
- (b) facilities for changing and for the storage and drying of clothing;
- (c) accommodation for taking meals and for taking shelter during interruption of work due to adverse weather conditions.

3. Men and women workers should be provided with separate sanitary and washing facilities.

Article 33

Information and training

Workers shall be adequately and suitably –

- (a) informed of potential safety and health hazards to which they may be exposed at their workplace;
- (b) instructed and trained in the measures available for the prevention and control of, and protection against, those hazards.

Article 34

Reporting of accidents and diseases

National laws or regulations shall provide for the reporting to the competent authority within a prescribed time of occupational accidents and diseases.

PART IV. IMPLEMENTATION

Article 35

Each Member shall –

- (a) take all necessary measures, including the provision of appropriate penalties and corrective measures, to ensure the effective enforcement of the provisions of the Convention;
- (b) provide appropriate inspection services to supervise the application of the measures to be taken in pursuance of the Convention and provide these services with the resources necessary for the

accomplishment of their task, or satisfy itself that appropriate inspection is carried out.

Safety and Health in Construction Recommendation, 1988 (No. 175)

(extracts)

PART I. SCOPE AND DEFINITIONS

1. The Provisions of the Safety and Health in Construction Convention, 1988 (hereinafter referred to as “the Convention”), and of this Recommendation should be applied in particular to:

- (a) building, civil engineering and the erection and dismantling of prefabricated buildings and structures, as defined in Article 2(a) of the Convention;
- (b) the fabrication and erection of oil rigs, and of offshore installations while under construction on shore.

2. For the purposes of this Recommendation –

- (a) the term “construction” covers:
 - (i) building, including excavation and the construction, structural alteration, renovation, repair, maintenance (including cleaning and painting) and demolition of all types of buildings or structures;
 - (ii) civil engineering, including excavation and the construction, structural alteration, repair, maintenance and demolition of, for example, airports, docks, harbours, inland waterways, dams, river and avalanche and sea defence works, roads and highways, railways, bridges, tunnels, viaducts and works related to the provision of services such as communications, drainage, sewerage, water and energy supplies;
 - (iii) the erection and dismantling of prefabricated buildings and structures, as well as the manufacturing of prefabricated elements on the construction site;
- (b) the term “construction site” means any site at which any of the processes or operations described in clause (a) above are carried on;
- (c) the term “workplace” means all places where workers need to be or to go by reason of their work and which are under the control of an employer as defined in clause (f) below;
- (d) the term “worker” means any person engaged in construction;
- (e) the term “workers’ representatives” means persons who are recognized as such under national law or practice;
- (f) the term “employer” means:

- (i) any physical or legal person who employs one or more workers on a construction site; and
- (ii) as the context requires, the principal contractor, the contractor or the subcontractor;
- (g) the term “competent person” means a person possessing adequate qualifications, such as suitable training and sufficient knowledge, experience and skill for the safe performance of the specific work. The competent authorities may define appropriate criteria for the designation of such persons and may determine the duties to be assigned to them;
- (h) the term “scaffold” means any temporary structure, fixed, suspended or mobile, and its supporting components which is used for supporting workers and materials or to gain access to any such structure, and which is not a “lifting appliance” as defined in clause (i) below;
- (i) the term “lifting appliance” means any stationary or mobile appliance used for raising or lowering persons or loads;
- (j) the term “lifting gear” means any gear or tackle by means of which a load can be attached to a lifting appliance but which does not form an integral part of the appliance or load.

3. The provisions of this Recommendation should also apply to such self-employed persons as may be specified by national laws or regulations.

PART II. GENERAL PROVISIONS

4. National laws or regulations should require that employers and self-employed persons have a general duty to provide a safe and healthy workplace and to comply with the prescribed safety and health measures.

5. (1) Whenever two or more employers undertake activities at one construction site, they should have the duty to cooperate with one another as well as with any other persons participating in the construction work being undertaken, including the owner or his representative, in order to comply with the prescribed safety and health measures.

(2) Ultimate responsibility for the coordination of safety and health measures on the construction site should rest with the principal contractor or such other person as is primarily responsible for the execution of the work.

6. The measures to be taken to ensure that there is organized cooperation between employers and workers to promote safety and health at construction sites should be prescribed by national laws or

regulations or by the competent authority. Such measures should include –

- (a) the establishment of safety and health committees representative of employers and workers with such powers and duties as may be prescribed;
- (b) the election or appointment of workers’ safety delegates with such powers and duties as may be prescribed;
- (c) the appointment by the employer of suitably qualified and experienced persons to promote safety and health;
- (d) the training of safety delegates and safety committee members.

7. Those concerned with the design and planning of a construction project should take into account the safety and health of the construction workers in accordance with national laws, regulations and practice.

8. The design of construction equipment, tools, protective equipment and other similar equipment should take account of ergonomic principles.

PART III. PREVENTIVE AND PROTECTIVE MEASURES

9. Construction work should be planned, prepared and undertaken in such a way that –

- (a) risks liable to arise at the workplace are prevented as soon as possible;
- (b) excessively or unnecessarily strenuous work positions and movements are avoided;
- (c) organization of work takes into account the safety and health of workers;
- (d) materials and products are used which are suitable from a safety and health point of view;
- (e) working methods are employed which protect workers against the harmful effects of chemical, physical and biological agents.

10. National laws or regulations should provide for the notification to the competent authority of construction sites of such size, duration or characteristics as may be prescribed.

11. Workers should have the right and the duty at any workplace to participate in ensuring safe working conditions to the extent of their control over the equipment and methods of work and to express views on the working procedures adopted as they may affect safety and health.

Safety of workplaces

12. Housekeeping programmes should be established and implemented on construction sites which should include provision for –

- (a) the proper storage of materials and equipment;
- (b) the removal of waste and debris at appropriate intervals.

13. Where workers cannot be protected against falls from heights by any other means –

- (a) adequate safety nets or safety sheets should be erected and maintained; or
- (b) adequate safety harnesses should be provided and used.

14. The employer should provide the workers with the appropriate means to enable them to use individual protective equipment and should ensure its proper use. Protective equipment and protective clothing should comply with standards set by the competent authority, taking into account as far as possible ergonomic principles.

15.(1) The safety of construction machinery and equipment should be examined and tested by type or individually, as appropriate, by a competent person.

(2) National laws and regulations should take into consideration the fact that occupational diseases may be caused by machinery, apparatus and systems which do not take account of ergonomic principles in their design.

Scaffolds

16. Every scaffold and part thereof should be of suitable and sound material and of adequate size and strength for the purpose for which it is used and be maintained in a proper condition.

17. Every scaffold should be properly designed, erected and maintained so as to prevent collapse or accidental displacement when properly used.

18. The working platforms, gangways and stairways of scaffolds should be of such dimensions and so constructed and guarded as to protect persons against falling or being endangered by falling objects.

19. No scaffold should be overloaded or otherwise misused.

20. A scaffold should not be erected, substantially altered or dismantled except by or under the supervision of a competent person.

21. Scaffolds as prescribed by national laws or regulations should be inspected, and the results recorded, by a competent person –

- (a) before being taken into use;

- (b) at periodic intervals thereafter;
- (c) after any alteration, interruption in use, exposure to weather or seismic conditions or any other occurrence likely to have affected their strength or stability.

Lifting appliances and lifting gear

22. National laws or regulations should prescribe the lifting appliances and items of lifting gear which should be examined and tested by a competent person –

- (a) before being taken into use for the first time;
- (b) after erection on a site;
- (c) subsequently at intervals prescribed by such national laws or regulations;
- (d) after any substantial alteration or repair.

23. The results of the examinations and tests of lifting appliances and items of lifting gear carried out in pursuance of Paragraph 22 above should be recorded and, as required, made available to the competent authority and to employers and workers or their representatives.

24. Every lifting appliance having a single safe working load and every item of lifting gear should be clearly marked with its maximum safe working load.

25. Every lifting appliance having a variable safe working load should be fitted with effective means to indicate clearly to the driver each maximum safe working load and the conditions under which it is applicable.

26. A lifting appliance or item of lifting gear should not be loaded beyond its safe working load or loads, except for testing purposes as specified by and under the direction of a competent person.

27. Every lifting appliance and every item of lifting gear should be properly installed so as, inter alia, to provide safe clearance between any moving part and fixed objects, and to ensure the stability of the appliance.

28. Where necessary to guard against danger, no lifting appliance should be used without the provision of suitable signalling arrangements or devices.

29. The drivers and operators of such lifting appliances as are prescribed by national laws or regulations should be –

- (a) of a prescribed minimum age;
- (b) properly trained and qualified.

Transport, earth-moving and materials-handling equipment

30. The drivers and operators of vehicles and of earth-moving or materials-handling equipment should be persons trained and tested as required by national laws or regulations.

31. Adequate signalling or other control arrangements or devices should be provided to guard against danger from the movement of vehicles and earth-moving or materials-handling equipment. Special safety precautions should be taken for vehicles and equipment when manoeuvring backwards.

32. Preventive measures should be taken to avoid the fall of vehicles and earth-moving and materials-handling equipment into excavations or into water.

33. Where appropriate, earth-moving and materials-handling equipment should be fitted with structures designed to protect the operator from being crushed should the machine overturn, and from falling material.

Excavations, shafts, earthworks, underground works and tunnels

34. Shoring or other support for any part of an excavation, shaft, earthworks, underground works or tunnel should not be erected, altered or dismantled except under the supervision of a competent person.

35.(1) Every part of an excavation, shaft, earthworks, underground works and tunnel where persons are employed should be inspected by a competent person at the times and in the cases prescribed by national laws or regulations, and the results recorded.

(2) Work should not be commenced therein until after such an inspection.

Work in compressed air

36. The measures regarding work in compressed air prescribed pursuant to Article 21 of the Convention should include provisions regulating the conditions in which the work is to be carried out, the plant and equipment to be used, the medical supervision and control of workers and the duration of work in compressed air.

37. A person should only be allowed to work in a caisson if it has been inspected by a competent person within such preceding period as is prescribed by national laws or regulations; the results of the inspection should be recorded.

Pile driving

38. All pile-driving equipment should be of good design and construction taking into account as far as possible ergonomic principles, and properly maintained.

39. Pile driving should be carried out only under the supervision of a competent person.

Work over water

40. The provisions regarding work over water prescribed in pursuance of Article 23 of the Convention should include, where appropriate, the provision and use of suitable and adequate –

- (a) fencing, safety nets and safety harnesses;
- (b) life vests, life preservers, manned boats (motor driven if necessary) and lifebuoys;
- (c) protection against such hazards as reptiles and other animals.

Health hazards

41.(1) An information system should be set up by the competent authority, using the results of international scientific research, to provide information for architects, contractors, employers and workers' representatives on the health risks associated with hazardous substances used in the construction industry.

(2) Manufacturers and dealers in products used in the construction industry should provide with the products information on any health risks associated with them and on the precautions to be taken.

(3) In the use of materials that contain hazardous substances and in the removal and disposal of waste, the health of workers and of the public and the preservation of the environment should be safeguarded as prescribed by national laws and regulations.

(4) Dangerous substances should be clearly marked and provided with a label giving their relevant characteristics and instructions on their use. They should be handled under conditions prescribed by national laws and regulations or by the competent authority.

(5) The competent authority should determine which hazardous substances should be prohibited from use in the construction industry.

42. The competent authority should keep records of monitoring of the working environment and assessment of workers' health for a period prescribed by national laws and regulations.

43. The manual lifting of excessive weights which presents a safety and health risk to workers should be avoided by reducing the weight, by the use of mechanical devices or by other means.

44. Whenever new products, equipment and working methods are introduced, special attention should be paid to informing and training workers with respect to their implications for safety and health.

transportation between the site and their homes or other suitable living accommodation is not available. Men and women workers should be provided with separate sanitary, washing and sleeping facilities.

Dangerous atmospheres

45. The measures regarding dangerous atmospheres prescribed pursuant to Article 28, paragraph 3, of the Convention should include prior written authority or permission from a competent person, or any other system by which entry into any area in which a dangerous atmosphere may be present can be effected only after completing specified procedures.

Fire precautions

46. Where necessary to guard against danger, workers should be suitably trained in the action to be taken in the event of fire, including the use of means of escape

47. Where appropriate suitable visual signs should be provided to indicate clearly the directions of escape in case of fire.

Radiation hazards

48. Stringent safety regulations should be drawn up and enforced by the competent authority with respect to construction workers engaged in the maintenance, renovation, demolition or dismantling of any buildings in which there is a risk of exposure to ionising radiations, in particular in the nuclear power industry.

First aid

49. The manner in which first-aid facilities and personnel are to be provided in pursuance of Article 31 of the Convention should be prescribed by national laws or regulations drawn up after consulting the competent health authority and the most representative organisations of employers and workers concerned

50. Where the work involves risk of drowning, asphyxiation or electric shock, first-aid personnel should be proficient in the use of resuscitation and other life-saving techniques and in rescue procedures.

Welfare

51. In appropriate cases, depending on the number of workers, the duration of the work and its location, adequate facilities for obtaining or preparing food and drink at or near a construction site should be provided, if they are not otherwise available.

52. Suitable living accommodation should be made available for the workers at construction sites which are remote from their homes, where adequate

Other ILO publications

Safety and health in construction.

An ILO code of practice

Changes in working practices and conditions in the construction industry over the past decade have meant that competent authorities, health and safety committees, management or employers' and workers' organizations, in particular, should take a fresh look at such aspects as the safety of workplaces, health hazards, and construction equipment and machinery. This code of practice takes account of new areas in the sector which require improved health and safety practices and other protective measures.

ISBN 92-2-107104-9 (1992) 20 Swiss francs

The organization of first aid in the workplace

Occupational Safety and Health Series No. 63

This publication is intended for public authorities, employers, workers, safety and health committees, and all persons in charge of occupational safety and health at the enterprise level. It shows in detail how first aid may be organized in the workplace, especially in small enterprises. It also provides information on the duties and training of first-aid personnel, the necessary equipment, supplies and facilities, and the arrangements required beyond first aid for accidents demanding specialized medical care.

Second impression 1999

ISBN 92-2-106440-9 15 Swiss francs

Safety and health in the use of chemicals at work: A training manual, by Abu Bakar Che Man and David Gold

This non-technical manual offers clear guidance on the risks associated with chemicals at work, and ways of reducing them. It covers health hazards resulting from chemical exposure, fire and explosion hazards, principles of prevention, chemical emergency procedures and management of a chemical control programme. Although specially designed for use on training courses, it will be invaluable to all those who promote the safe use of chemicals at work. Includes numerous illustrations, suggestions for discussion and activities, and a comprehensive checklist.

ISBN 92-2-106470-0 (1993) 17.50 Swiss francs

Ergonomic checkpoints: Practical and easy-to-implement solutions for improving safety, health and working conditions

This unique compilation of 128 "ergonomic checkpoints" identifies simple and inexpensive solutions to ergonomic problems in a variety of workplaces and local situations. The checkpoints, which can be used to check working conditions or workplace plans, cover storage and handling, hand tools, machine safety, workstation design, lighting, premises, hazardous substances, welfare facilities and work organization. Each checkpoint is illustrated, and a complete ergonomic checklist is included. Prepared in collaboration with the International Ergonomics Association.

Second impression (with revisions) 1999

ISBN 92-2-109442-1 25 Swiss francs

Encyclopaedia of Occupational Health and Safety. Fourth edition.

Edited by Jeanne M. Stellman, PhD

Completely revised and greatly expanded, the new edition of the Encyclopaedia provides comprehensive and authoritative coverage of occupational health and safety. It was developed through an extensive process of consultation with leading professionals and worldwide health and safety institutions. A new CD-ROM version provides the benefits of computer-assisted search and retrieval capabilities. The Encyclopaedia consists of four printed volumes:

- Volume 1: The body, health care, management and policy, tools and approaches
- Volume 2: Psychosocial and organizational factors, hazards, the environment, accidents and safety
- Volume 3: Chemicals, industries and occupations

- Volume 4: Indexes by subject, author, chemical name; cross-reference guide and directory of contributors.

"Specialists and non-specialists alike will find the Encyclopaedia an invaluable reference book and indispensable primary resource when responding to critical questions involving health and safety in the workplace." (*Health and Safety*, January 1999)

ISBN 92-2-109203-8 (4 bound volumes, 1999): 550 Swiss francs

ISBN 92-2-109818-4 (CD-ROM, 1999): 550 Swiss francs

ISBN 92-2-110403-6 (Set (printed volumes & CD-ROM)): 1100 Swiss francs

Improve Your Construction Business Series

The Improve Your Construction Business (IYCB) Series is designed to suit the needs of small-scale building and public-works contractors and includes, within each title, both a handbook, which provides ideas and information, and a workbook, which guides the reader through worked exercises and action plans. The series consists of the following titles:

Pricing and bidding (IYCB-1) Handbook and Workbook.

by C.-A. Andersson, D. Miles, R. Neale and J. Ward

This first Handbook takes the reader step by step through the preparation of a bid for a small building contract and, together with its companion Workbook, should help businesses to win profitable contracts and to become more competitive and successful.

ISBN 92-2-109160-0 (Set of two books, 1994) 27.50 Swiss francs

ISBN 92-2-108738-7 (Handbook) 15 Swiss francs

ISBN 92-2-108748-4 (Workbook) 15 Swiss francs

Site management (IYCB-2) Handbook and Workbook

by C.-A. Andersson, D. Miles, R. Neale and J. Ward

The second Handbook and Workbook in the IYCB series take over at the stage where a potentially profitable contract has been won. They cover the principles and practice of site supervision, as well as a discussion of effective work planning.

ISBN 92-2-109315-8 (Set of two books, 1996) 27.50 Swiss francs

ISBN 92-2-108753-0 (Handbook) 15 Swiss francs

ISBN 92-2-108754-9 (Workbook) 15 Swiss francs

Business management (IYCB-3) Handbook and Workbook by C.-A.

Andersson, D. Miles, R. Neale and J. Ward

The third Handbook and Workbook cover the management of a business enterprise and focus on financial control and office administration.

ISBN 92-2-109314-X (Set of two books, 1996) 27.50 Swiss francs

ISBN 92-2-108755-7 (Handbook) 15 Swiss francs

ISBN 92-2-108756-5 (Workbook) 15 Swiss francs

Building for tomorrow: International experience in construction industry development, by Derek Miles and Richard Neale

This book focuses on the institutional network required to ensure that the construction industry is effective and competitive. In industrialized countries this institutional framework has evolved gradually, but in developing and newly industrializing countries the process has been accelerated, and managers have had to embark on a "journey without maps". The authors provide a handbook of ideas, methods and techniques to assist pioneering institutions to develop the industry. Aimed at policy-makers faced with complaints about inadequate construction performance, and construction professionals and students, its analysis of the working of technical co-operation projects and the interaction between institutions will also be of interest to development specialists.

ISBN 92-2-107284-3 (1991) 30 Swiss francs

Safety, health and welfare on construction sites

A training manual



Known injuries, accidents and work-related illnesses on construction sites frequently exceed those in any other manufacturing industry. It is therefore imperative to improve the safety and health record in construction work.

If you are employed in construction – as a worker or a workers' representative, or as a supervisor – you will naturally be concerned that your work, and that of your colleagues, should be safe and healthy. This clear, easy-to-read manual helps you to consider safety, health and welfare conditions on construction sites in your country and to learn about possible solutions to the problems you encounter. It covers all aspects of work on construction sites:

- 
- Safety organization and management
 - Site planning and layout
 - Excavations, scaffolding and use of ladders
 - Hazardous processes
 - Movement of materials
 - Working positions, tools and equipment
 - The working environment
 - Personal protective equipment
 - Welfare facilities



The manual will also be useful to employers and managers who are responsible for ensuring safe and healthy working conditions on site, and is particularly suitable for use on training courses. It is intended to complement the ILO code of practice Safety and health in construction.

- Numerous illustrations
- Includes topics for discussion
- Contains a comprehensive checklist on safety, health and welfare on construction sites

Price: 25 Swiss francs

ISBN 92-2-109 182-1